



Instructions
Infrared emitter Group 04
Short-wave/high-speed medium-wave/hybrid, with insulated connecting wires, for horizontal operation only, additionally 2D or 3D shaped with special requirements for installation and care

Infrared emitter Group 04

Short-wave/high-speed medium-wave/hybrid, with insulated connecting wires, for horizontal operation only, additionally 2D or 3D shaped with special requirements for installation and care

Manufacturer

**Excelitas Noblelight GmbH
Infrarot Prozesstechnik**

Reinhard-Heraeus-Ring 7
63801 Kleinostheim, Germany

Telephone: +49 6181 35-8545

Fax: +49 6181 35-8410

www.noblelight.com

Mail: hng-infrared@heraeus.com

Excelitas Noblelight reserves all rights to this operation manual .

The text, information and illustrations in this manual must not be reproduced, distributed or disclosed to third parties or used without authorisation for purposes of competition.

This operation manual was prepared with great care. However, should you detect an error in it, we would appreciate if you let us know.

Table of contents

1 Introduction	4
1.1 Risk assessment	4
2 Safety instructions	6
2.1 List of the symbols used.....	6
2.2 Target group, personnel qualifications	7
2.3 Basic safety instructions.....	7
3 Product description	12
3.1 Intended use	12
3.2 Ambient conditions	13
4 Installation conditions	14
5 Transport	17
6 Storage	18
7 Mounting	19
7.1 Clamping/spring holders	20
7.2 Emitter fastening	22
7.3 Installing the emitter	24
7.4 Checking the system	24
8 Pilot emitter design	25
9 Maintenance and cleaning	26
10 Disposal	28
11 EU/UKCA Declaration of Conformity	29

1 Introduction

This instruction manual provides instructions for assembly, use and care of the product.

It is for use by personnel installing, operating and servicing the product.



- ➔ Read this operation manual prior to initial operation.
- ➔ Observe the instructions given in the operation manual.
- ➔ Ensure that this operation manual is available to all persons handling the product.
- ➔ Make sure the operation manual can be consulted at any time during the service life of the product.



Excelitas Noblelight cannot be held liable for any damage or disturbance of operations caused by non-compliance with the instructions given in the operation manual.

The proper function of the product is guaranteed only if:

- ➔ The product is mounted in accordance with instructions.
- ➔ The operation manual and maintenance recommendations are observed.
- ➔ Original Excelitas Noblelight components are used for mounting.

Text markup

The markups used in the text indicate the following:

- **Bold** = important information
- *Italics* = reference to a chapter, or a menu item
- ➔ = instruction; something needs to be done

1.1 Risk assessment

Excelitas Noblelight offers powerful light sources that are optimised for the specific application and hence have a high ultraviolet (UV), visible (VIS) and infrared (IR) radiation capacity, depending on lamp type, which may be a risk to the user (artificial optical radiation (AOR)).

Various sources of information, in the form of harmonised standards and technical rules, together with European Directives and national laws, are available to facilitate the safe use of these lamps and systems, or the devices and machines in which they are incorporated. These documents contain requirements and guidelines for risk group classification, AOR risk assessment, technical design, technical control, marking and possible safety precautions for users.

- ➔ Possible standards that may be taken into account:
 - EN 62471
 - IEC/TR 62471-2
 - EN 12198-1
 - EN 14255-1/-2
 - EN 60519-1
 - EN 60519-12
 - ISO 13577-1

EU Directive 2006/25/EC on the minimum health and safety requirements regarding the exposure of workers to risks arising from artificial optical radiation provides that employers must assess whether and to what extent harmful optical radiation, including UV and IR radiation, is emitted by the product and what the exposure risks are for workers in the vicinity, e.g. foreseeable duration of exposure and foreseeable accessible distances. This is a legal obligation of the employer with respect to health and safety at the workplace and not a product-related legal obligation of the manufacturer.

The employer can use the end-product manufacturer's operation manuals to help it assess the exposure risk at the workplace but they do not release the employer from its legal obligation to perform a risk assessment itself because, in particular, the hazards from artificial optical radiation caused by the use of the product at the workplace can be assessed only under the final user conditions. Based on the results of the workplace risk assessment, the employer must take appropriate measures to protect the user against hazards, including risks from artificial optical radiation. The risk assessment shall include, without limitation, the following areas:

- The effect of the artificial optical radiation generated by the product on the materials and users in the vicinity if the product is used as intended.
- The fire hazard that may arise due to the product being a source of heat if used as intended.
- The requirements regarding adequate ventilation and/or extraction if used as intended.
- Ambient conditions under which the product is to be operated or stored, such as temperature and relative air humidity.
- Safe working practices for working with the product.
- In addition to the operation manual, all applicable legal and other regulations regarding accident prevention and protection of the environment must be observed.

2 Safety instructions



→ Observe the safety instructions.

⇒ Non-observance of the safety instructions causes hazards to persons, the environment and the product.

2.1 List of the symbols used

Various symbols are used in this operation manual to identify the remaining risks of the different hazard levels. The symbols help the user detect and memorise risks.







Signal words

The signal word "**DANGER**" indicates a high-risk hazard which, if not avoided, will cause death or severe injury.







The signal word "**WARNING**" indicates a medium-risk hazard which, if not avoided, may cause death or severe injury.

The signal word "**CAUTION**" indicates a low-risk hazard which, if not avoided, may cause minor or moderately severe injury.

Warning signs

	Generic warning		Risk of electrical shock
	Fire hazard		Warning of hot surface
	Warning of optical radiation hazard Infrared radiation		Warning of injury to hands (cutting)
	Warning of injury to hands (crushing)		

Mandatory action symbols

	Read the instruction manual.		Notes regarding optimal use.
	Wear safety glasses.		Wear face protection/visor.
	Wear hand protection.		Disconnect from the mains before carrying out any work.

2.2 Target group, personnel qualifications

Task	Qualification
Transport	Technical qualification
Installation	Technical qualification
Electrical connection	Electrician
Lamp replacement	Electrically instructed personnel
Maintenance	Technical qualification

2.3 Basic safety instructions

Personal protective equipment

- Use the following personal protective equipment when handling the product:



Protective gloves

- Wear uncoated cut-resistant gloves to avoid being cut.
- Wear vinyl gloves to avoid grease and sweat on the infrared emitter.
- We recommend wearing uncoated cut-resistant gloves (see EN 388) and vinyl gloves underneath.



Eye protection

- When working with the product, wear safety goggles/face shield to prevent injury caused by splinters.
- During operation, wear appropriate safety goggles to protect you from optical radiation.

Explosion hazard



DANGER

Operation in explosion-risk areas

Potentially explosive atmospheres may be ignited at the infrared emitter and at the surface heated.

The solvent vapour concentration must be less than 25% of the lower explosion limit. This also applies to flammable dusts and all organic dusts.

- Observe standard EN 1539 where a potentially explosive atmosphere may be created due to solvent vapour-air mixtures or accumulation of dust.
- Released vapours and dusts must be extracted by means provided by the client.
- Observe the safety regulations regarding the processing of coating materials.



Heated surfaces and the infrared emitter itself may be hot enough to act as an ignition source even a long time after switch-off.

Risk of electrical shock

The infrared emitters and their connecting wires only have a basic insulation protection against direct contact.



⚠ DANGER

Dangerous voltage

Risk of electric shock when working on live components. Danger to life.

- ➔ De-energise the product.
- ➔ Secure against restarting.
- ➔ Check that the product is de-energised.

Dangerous electric voltage is present:

- At bared connecting wires and other connecting components. The dangerous voltage may be present even if the infrared emitter itself remains dark.
 - Overheating or mechanical impact will cause damage to the insulation of the connecting wires.
 - When infrared emitters break during operation.
- ➔ Arrange the infrared emitters in the machine in such a way that they and the connecting wires cannot be touched during operation.
 - ➔ Make the infrared emitters accessible only after disconnecting them from the mains.

Danger due to leakage current



⚠ DANGER

Danger due to leakage current

Infrared emitters have a leakage current. The screws and nuts used to mount the emitter may be live if not properly mounted.

- ➔ Inhibit or limit the leakage current by:
 - ⇒ Using original Excelitas Noblelight holders.
 - ⇒ Insulating the mountings of the infrared emitters.
 - ⇒ Observe the requirements regarding protective equipotential bonding for electrical installations with heating elements.
 - ⇒ Prevent exposed emitter fastenings from being touched during operation.

Fire hazard**⚠ DANGER****Danger of fire**

The heated surfaces and the hot surface of the infrared emitter pose a fire hazard.

- ➔ Prior to using the infrared emitters, check the suitability of the material to be heated and the process environment.
 - ➔ The use of self-igniting materials is prohibited.
 - ➔ Use in explosion hazard areas is prohibited.
-

**Note:**

After uncontrolled switch-off of the infrared emitters (e.g. emergency stop), the material to be heated may stand still under the infrared emitters that are still hot. There is a danger of ignition of the heated material due to the thermal energy stored in the infrared emitter.

- ➔ Take appropriate machine-side measures to prevent ignition.
 - ➔ Design the surroundings of the infrared emitter and the process chamber in such a way that possible flammable plant components (e.g. insulations, cables, wires etc.) are not located in the exposure area. They have to be shielded, so that no danger arises.
-

Inrush current**Note:**

Infrared emitters with a tungsten filament have an inrush current. The inrush current may be 17 times the rated current.

- ➔ The inrush current must be protected against or limited by suitable means.
 - ➔ Use components that are suitable for the inrush current.
 - ➔ Prevent weld and stick on of electric contacts.
-

Danger to eyes and skin



WARNING

Infrared radiation

Many infrared emitters moreover emit dangerous visible radiation in accordance with category 2 of EN 12198-1.

Eyes and unprotected skin exposed to direct or indirect radiation are at hazard.

- ➔ Protect persons by means of suitable personal protective equipment. No hazard must occur.
- ➔ Comply with the machinery directive and the directive regarding artificial optical radiation.
- ➔ Observe the safety instructions.
- ➔ Do not look into the radiation.
- ➔ Arrange the infrared emitters in the machine in such a way that the radiation cannot be looked at directly or indirectly during operation. The infrared emitters must be made visually accessible only after disconnection from the mains.



Non-glare design infrared emitters

Note:

Non-glare design infrared emitters (identifiable by the dark red coating of the quartz glass tube) as well fall into category 2 of EN 12198-1.

The coating merely allays the visual impression of the brightness of the infrared emitter and has no influence on the infrared radiation invisible to the human eye.

Danger of breaking



CAUTION

Warning of injury to hands

Infrared emitters are made of quartz glass which can break. When quartz glass breaks, the splinters have sharp edges that may cause injury.

- ➔ Wear protective clothing.
- ➔ Prevent the following:
 - ⇒ Single-sided mechanical stresses
 - ⇒ Heavy vibration
 - ⇒ Shock
 - ⇒ Contact with other machine parts
 - ⇒ Contact with the substrate to be heated
- ➔ Only use the original packaging to transport infrared emitters.

Risk of burning**CAUTION****Hot surface**

During operation and for a long time after switch-off, the infrared emitters and their surroundings have very hot surfaces.

Contact with the hot surface will cause burns.

- ➔ Secure hot surfaces against unintentional contact.
 - ➔ Arrange the infrared emitters in the machine in such a way that they cannot be touched during operation.
 - ➔ Make the infrared emitters accessible only after disconnecting them from the mains.
 - ➔ After switching them off, wait a sufficient time for the infrared emitters to cool down.
-

3 Product description

Infrared emitter Group 04

Short-wave/high-speed medium-wave/hybrid, with insulated connecting wires, for horizontal operation only, additionally 2D or 3D shaped with special requirements for installation and care

Infrared emitters are intended for use as a heat radiation source in plants or machines for industrial heating or drying processes.

Scope of supply

- Quick guide with the most important safety instructions
- Cleaning cloth

Clamping springs and retaining springs for installation are enclosed in the delivery if ordered.

Dimensions of the infrared emitters see the order acknowledgement.

3.1 Intended use

Infrared emitters are intended for use in industrial electroheat installations such as those used for heating or drying processes.

Reasonably foreseeable misuse

The following exclusions apply, among others:

- Use to expose humans or animals to radiation.
- Use for non-industrial applications such as for wellness or medical treatment.
- Use for general lighting purposes.
- Use outdoors.
- Use in wet atmospheres (air humidity > 80%, condensing)
- Use in explosive or combustible atmospheres.



DANGER

Operation in explosion-hazard areas

→ Use in explosion hazard areas is prohibited.



The product is a special-purpose product as defined in the current version of EU Regulation 2019/2020 regarding ecodesign requirements for light sources in accordance with Directive 2009/125/EC.

→ This product must not be used for general lighting.

→ Any use of the product in other than the intended applications is not admissible.



→ Any use not specified in the operation manual requires approval by Excelitas Noblelight.

3.2 Ambient conditions

Our products are used in a multitude of very different processes, plants and environments. Any list of environmental conditions cannot be exhaustive.

Safe operation of the Infrared emitter is guaranteed if the listed environmental conditions are observed:

- | | |
|-------------------|---|
| Operation | <ul style="list-style-type: none"> ■ By trained personnel only. ■ No intensive UV radiation at the wires. |
| Dust | <ul style="list-style-type: none"> ■ No dust deposits. ■ No deposits of electrically conductive fibres. |
| Biogenic | <ul style="list-style-type: none"> ■ No fouling from biofilms. ■ No animals. |
| Water | <ul style="list-style-type: none"> ■ Air humidity < 95% at 40°C or < 30 g/m³. ■ Dripping water is acceptable for a short time but formation of films is not, e.g. carbonates. |
| Chemical | <ul style="list-style-type: none"> ■ No contact with seawater or seawater spray. ■ No combination of phosphorus and high temperatures above 800°C. ■ No contact with alkali or alkaline earth metals. ■ No contact with selenium. ■ Partial pressure of hydrogen below 10 ppm. ■ No contact with fluorine. |
| Mechanical | <ul style="list-style-type: none"> ■ Never shock. ■ No excessive mechanical stresses. ■ No abrasive materials. ■ Detailed limits exist for acceleration and vibration, which are specified in our customer information regarding the service life of Excelitas Noblelight infrared emitters. |
| Electrical | <ul style="list-style-type: none"> ■ Continuous operation at up to 100% of the rated voltage is admissible. ■ Avoid very strong magnetic fields. ■ Under a vacuum, specific electrical conditions must be observed. |
| Thermal | <ul style="list-style-type: none"> ■ Ambient conditions < 200°C. ■ Temperature of the electrical supply lines < 220°C. ■ Temperature of the pinch < 250°C. ■ Temperature of the emitter tube for uncoated emitters or QRC emitters < 700°C. ■ Temperature of the emitter tube for gold-plated emitters < 600°C. |

4 Installation conditions

The components used (e.g. electrical terminals) must be suitable for the ambient conditions.

- ➔ Consider the self-heating of the connecting wire in combination with the ambient temperature.

All parts of the infrared emitter must be located inside the plant or machine.

Among other things, the plant/machine must ensure protection of the operator and personnel against the hazards originating from the infrared emitter (protection against electric shock, heat, infrared radiation and mechanical injury).

- ➔ Operate the infrared emitter only in the specified operating position.

Explosion hazard area



DANGER

Operation in explosion-hazard areas

- ➔ Use in explosion hazard areas is prohibited.



Infrared emitters are not intended for use in potentially explosive or combustible atmospheres.

Use in potentially explosive or combustible atmospheres is permitted only as part of a device which in its entirety meets the requirements of the ATEX Directive as amended from time to time and the corresponding harmonised standards.

The distributor of the machine is responsible for ensuring this.



Rated voltage

Prolonged operation at voltages higher than the rated voltage will cause destruction or substantially reduce the service life of the infrared emitters.

- ➔ Infrared emitters must not be operated with a voltage higher than the defined rated voltage taking account of the constant voltage specified in EN 60519-1, *Safety in installations for electroheating*.



Mains frequency

Infrared emitters are designed for 50/60 Hz mains frequency.

Mains frequencies < 200 Hz are admissible.

Humidity, water



WARNING

Dangerous voltage

The infrared emitters and their connecting wires have a basic insulation protection against direct contact.

Infrared emitters are not intended for use in water.

Dripping water can be tolerated if electrical safety is guaranteed by the plant.

→ Arrange the infrared emitters in the machine in such a way that the infrared emitters and the connecting wires cannot be touched and are not accessible.



Contamination of ultra-pure liquids or gases by quartz glass, socket or connecting wires is not ruled out.

→ Make sure that contamination does not occur.

Connecting wires



Max. temperature of the connecting wires: 220°C. If the maximal temperature of the connecting wire is exceeded, the electrical insulating property is no longer guaranteed. **The infrared emitter needs to be replaced.**

→ Do not exceed the maximal rated current (which is reached at the rated voltage taking account of the fluctuation permitted in acc. w. IEC 60038).

→ Protect the connecting wires against UV radiation.

→ Do not expose the connecting wires to corrosive media.



Do not bundle the connecting wires.

If connecting wires are bundled, there is a danger of overheating already at substantially lower temperatures. Higher temperatures or currents will destroy the connecting wires.



The connecting wires are not designed to withstand heavy vibration.

→ Avoid heavy vibration and cyclical movements.

Electrical fuse protection of the system

Short-wave infrared emitters have an increased current consumption at the moment of switch-on, which may be up to 17 times the rated current.

Carbon infrared emitters do not have an increased inrush current.

Temperature at the gold reflector



WARNING

Generic warning

The temperature of the gold reflector must not exceed 600°C in any operating condition.

Otherwise, the reflection properties of the gold will be damaged irreversibly.

Components will overheat due to the increased infrared radiation emitted.

➔ Replace the infrared emitter if its gold reflector is damaged.

All-around gold-plated
infrared emitter version

CAUTION! The all-around gold-plated emitter must be put into operation only after creation of the light exit gap. Failure to observe this will cause irreparable damage to the gold reflector.

Temperature at pinch and socket



WARNING

Generic warning

The temperature of the pinch and the ceramic socket must not exceed 250°C.

The following will occur if the temperature is exceeded:

- Premature failure of the infrared emitters,
- breaking of the pinch,
- hazards due to bare live parts.

➔ Replace damaged Infrared emitter.

5 Transport



CAUTION

Warning of injury to hands (cutting)

When handling the packaging or the product, you can cut yourself at sharp edges.

→ Wear protective gloves.



→ Only use the original packaging to transport infrared emitters.

→ Protect the product against damage.

→ Avoid vibrations and impact.

→ Check that the packaging of the product is not damaged.
Any damage to the packaging may be the cause of a subsequent malfunction.

6 Storage

Storage conditions

Temperature range: -25°C to +55 °C, max. 70°C for 24 hours

→ Observe the following instructions for storing the infrared emitters:

- Store in original packaging, do not touch with your bare hands. remove grease and other soiling with a cloth soaked with alcohol,
 - store in a dry place,
 - protect against dust,
 - no direct sunlight,
 - do not place other objects onto the infrared emitters to avoid damage,
 - protect against shock and vibration.
-



→ When the infrared emitter was transported or stored at low temperatures or during great fluctuations of temperature ensure that no moisture condensation occurs at the infrared emitter.

→ Prior to installation and initial operation of the infrared emitter, the emitter must assimilate to the ambient temperature.

7 Mounting



CAUTION

Warning of injury to hands (cutting)

Quartz glass is fragile.

When quartz glass breaks, sharp edges and splinters are formed that may cause injury.

- Wear protective gloves and goggles.
- Make the lamp accessible only after disconnection from the mains.



Protective gloves

- Wear uncoated cut-resistant gloves to avoid being cut.
- Wear vinyl gloves to avoid grease and sweat on the infrared emitter.
- We recommend wearing uncoated cut-resistant gloves (see EN 388) and vinyl gloves underneath.

Transporting the Infrared emitter

- Use the packaging of the infrared emitters to transport them to the place of installation.
If the Infrared emitter needs to be transported without its packaging, wear suitable personal protective equipment.
- Use both hands to carry and mount the infrared emitter.

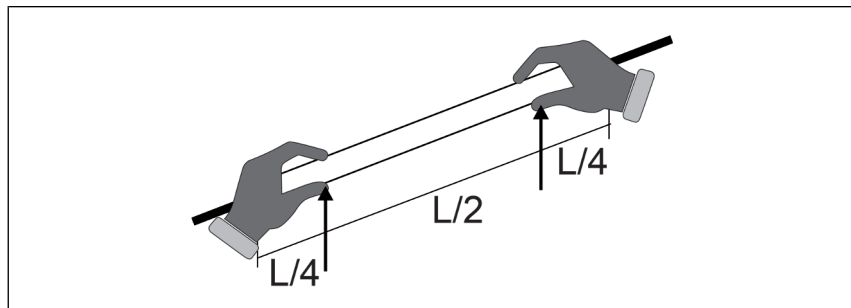

NOTICE! Never use the connecting wires, pinches or ceramic parts to carry the infrared emitter.

- Only touch the glass body when carrying the infrared emitter.
- Avoid any pressure on the seal.

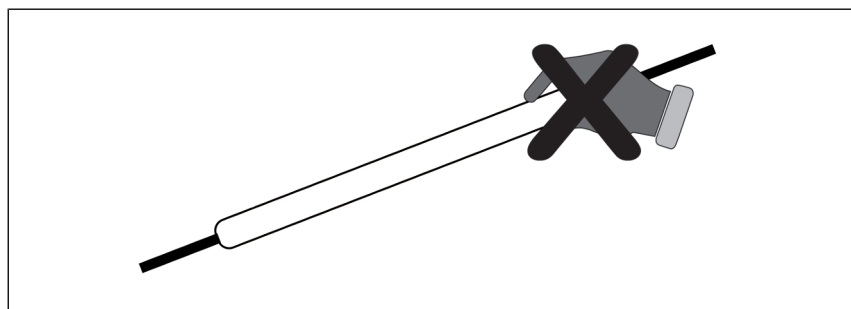

Installing the Infrared emitter





- ➔ To install the infrared emitters, use a clamping holder, a spring holder and, if necessary, one or several Excelitas Noblelight central supports.
- ➔ Observe the following chapters.

7.1 Clamping/spring holders

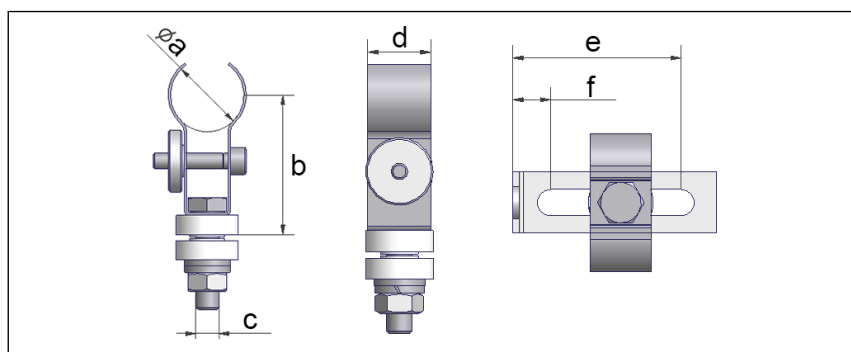
Holder dimensions

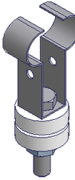
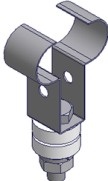

Picture	Description Tube size (mm)	Dimensions (mm)
	09759293 Clamping holder Round tube 10 1x per emitter	a = 10 b = 30 c = M4 d = 10
	09759292 Spring holder/central support Round tube 10	a = 10 b = 25 c = M4 d = 10
	80012075 Clamping holder for L-socket Round tube 10 1x per emitter	a = 10 b = 31.5 c = M4 d = 10 e = 52.5 f = 7.5
	80012076 Spring holder for L-socket Round tube 10 1x per emitter	a = 10 b = 31.5 c = M4 d = 10 e = 52.5 f = 7.5

Picture	Description Tube size (mm)	Dimensions (mm)
	80014997 Clamping holder Round tube 13 1x per emitter	a = 13.7 b = 30 c = M4 d = 10
	80014996 Spring holder/central support Round tube 13	a = 13.7 b = 30 c = M4 d = 10
	09759287 Clamping holder Twin tube 23 x 11 1x per emitter	a = 11 b = 31 c = M5 d = 10
	09759286 Spring holder/central support Twin tube 22 x 10/23 x 11	a = 11 b = 31 c = M5 d = 10
	09758026 Clamping holder Twin tube 34x14 1x per emitter	a = 15 b = 35.5 c = M6 d = 15
	09758018 Spring holder/central support Twin tube 33 x 15/34 x 14	a = 15 b = 35.5 c = M6 d = 15



Special care is required when planning and installing the emitter holder.

The infrared emitters are very sensitive to mechanical stress and torsion.

- ➔ Design the emitter holders in such a way that no mechanical stress is exerted on the infrared emitters during operation.
- ➔ Install the infrared emitters cautiously to avoid breaking them.

➔ Fasten the emitter mounts to a stable and torsion-free supporting structure, retaining plate, thickness ≥ 1.5 mm.

➔ Emitter mount material: high-temperature steel.

- ➔ When designing the supporting structure, take account of the thermal expansion during operation of the infrared emitters. Warping supporting structures or designs not taking account of thermal expansion may result in breakage and destruction of the infrared emitters.
- ➔ One emitter mount is to be a locating bearing and all others moveable bearings because quartz glass has an extremely low thermal expansion coefficient.



If the mounting rules are not observed, stresses will occur which will cause the infrared emitter to break.

7.2 Emitter fastening

Fastening points

- ➔ Determine emitter length L_g . Determine the emitter length either directly at the emitter or see the order acknowledgement.
- ➔ Drill the appropriate number of $\varnothing 9.2 \text{ mm}$ holes into the supporting structure at the intervals L (see picture below).

NOTICE! Carefully debur the holes.

Short-wave round tube emitter (dim. in mm)			
Tube size	Dimension A	Dimension B	Central support for horizontal operation
10	35	35	Use appropriate additional holders adjusted to emitter geometry and emitter stability.
13	40	40	

Short-wave twin-tube emitter curved (dimensions in mm)			
Tube size	Dimension A	Dimension B	Central support for horizontal operation
23 x 11	40	40	Use appropriate additional holders adjusted to emitter geometry and emitter stability.

34 x 14	50	50
---------	----	----

Emitter holder → Mount appropriate emitter holder (see chapter Clamping/spring holders [▶ Page 20]).

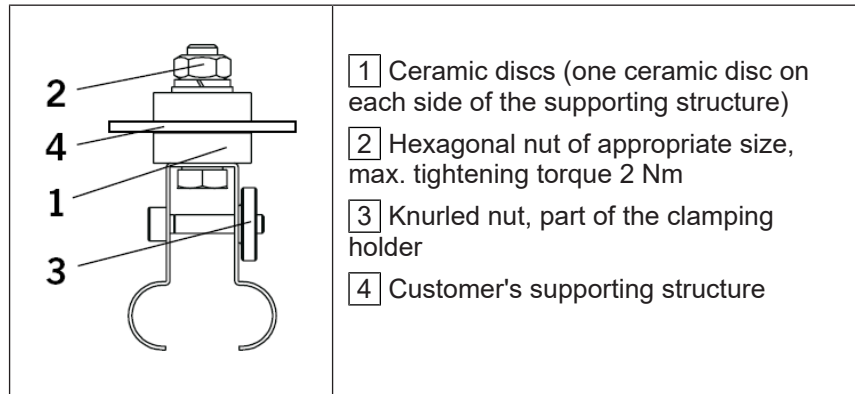

The ceramic discs isolate the emitter holders from the leakage current occurring in the infrared emitter.

→ Install both ceramic discs to guarantee the electrical safety of the system.

7.3 Installing the emitter

1. Undo the knurled nut **A**. The infrared emitter must easily engage in the emitter holder.

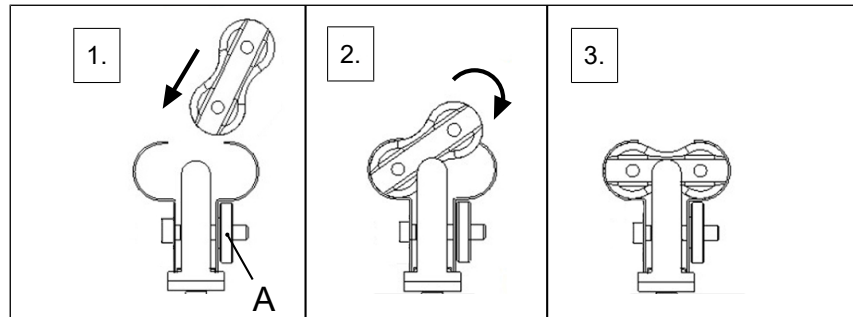

2. Insert the infrared emitter in such a way that the reflector (gold or QRC®) faces the supporting structure. The reflector must never point in the direction of the object to be heated.
3. Tighten the fastening nut and the knurled nut.

Connecting wires

Connecting wires must not exert any tensile or compressive force onto the infrared emitter.

Bending radii of the connecting wire must not be smaller than 7.5 times the radius of the outside diameter of the connecting wire.



- ➔ The connecting wires are not designed to withstand continuous movement.

- ➔ Route the connecting wires of the infrared emitters to the terminals.
- ➔ Do not bundle the connecting wires.
- ➔ If possible, cut the connecting wires to the required length. Press a wire-end sleeve onto the bare end of the connecting wire.
- ➔ Connect the connecting wires to the terminals provided for the purpose.



- ➔ After installation, clean all Infrared emitter, see chapter Maintenance and cleaning [▶ Page 26].

7.4 Checking the system

- ➔ After installation, check as follows:
 1. Check the entire system in accordance with EN 60519-1, *Safety in installations for electroheating – Part 1: General requirements*.
 2. Check the total power consumption for compliance with the specifications.

8 Pilot emitter design

A pilot emitter design infrared emitter can be equipped with a thermocouple for temperature measurement.

General information regarding the temperature measurement

- ➔ When integrating the measured temperature into an electrical control system of the infrared emitters, consider the effects on the overall plant, the process and the product to be heated.
- ➔ The plant operator must assess the hazards that occur in dependence on the influence of the measured temperature on the operating condition of the infrared emitters.



WARNING

Danger of fire

Incorrect temperature measurements have an influence on process reliability and safety.

Excess temperatures may occur if the temperature measurement is faulty which, depending on application, may even result in a fire.

- ➔ The customer must integrate additional thermal monitoring.

Thermowell

An appropriate thermowell is used to insert the thermocouple into the infrared emitter. The thermowell electrically insulates the thermocouple.

- ➔ Only install/use thermowells that are in good order. Replace damaged thermowells or infrared emitters with damaged thermowells.

NOTICE! A damaged thermowell may cause faulty temperature measurements.

Depending on the type of the infrared emitter, the thermowell is already put on at the infrared emitter or needs to be inserted into the infrared emitter by the customer.

The thermowell is closed at one end.

Thermocouple mounting

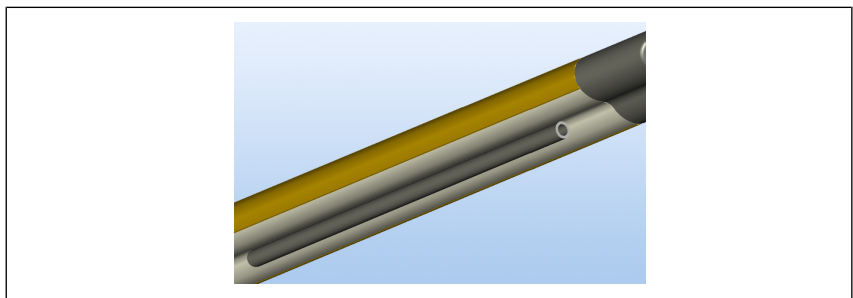

- ➔ Insert the thermocouple into the pilot tube at full length. Make sure that the thermocouple does not pierce the pilot tube. Secure the thermocouple to prevent mechanical stresses.
- ➔ Consider the expansion of the thermocouple during operation. Expansion may cause breakage of the pilot tube.
- ➔ Replace the infrared emitter if its pilot tube is damaged.
- ➔ Protect pilot emitters particularly against mechanical stresses.
- ➔ Contact Excelitas Noblelight if you have any questions.

9 Maintenance and cleaning



Maintenance and repair work must be carried out only by authorised expert personnel.

Failure to observe the safety instructions or improper handling of the product will cause injury and/or damage to property.



⚠ DANGER

Dangerous voltage

Risk of electric shock when working on live components. Danger to life.

- ➔ De-energise the product.
- ➔ Secure against restarting.
- ➔ Check that the product is de-energised.



⚠ CAUTION

Hot surface

During operation and for a long time after switch-off, the infrared emitters and their surroundings have very hot surfaces.

Contact with the hot surface will cause burns.

- ➔ Secure hot surfaces against unintentional contact.
- ➔ Arrange the infrared emitters in the machine in such a way that they cannot be touched during operation.
- ➔ Make the infrared emitters accessible only after disconnecting them from the mains.
- ➔ After switching them off, wait a sufficient time for the infrared emitters to cool down.



⚠ CAUTION

Warning of injury to hands (cutting)

Quartz glass is fragile.

When quartz glass breaks, sharp edges and splinters are formed that may cause injury.

- ➔ Wear protective gloves and goggles.
- ➔ Make the lamp accessible only after disconnection from the mains.

Infrared emitter are maintenance-free.

However, we recommend the scheduling of intervals for visual inspection and, if necessary, subsequent cleaning.

- ➔ Adjust the inspection intervals to the risk and degree of soiling in the process environment.

Cleaning



Fingerprints, fat or sweat on the quartz tube will result in devitrification and premature failure of the infrared emitter.

- Do not touch the infrared emitters with your bare hands.
 - Wear gloves.
We recommend wearing clean and powder-free latex gloves and clean textile gloves on top.
 - Immediately change soiled gloves.
-



Infrared emitters need to be cleaned to remove any soil and finger sweat prior to initial operation and following any maintenance.

- Use the cleaning cloth enclosed with the delivery or a clean cloth (no finish) soaked e.g. with ethanol.
 - **Do not** clean the reflector side of the infrared emitters.
-

10 Disposal

RoHS The product is subject to Directive 2011/65/EU and the UK Statutory Instrument 2012/3032, as amended from time to time, and contains none of the restricted substances specified in Annex II in concentrations higher than the admissible maximum in homogeneous materials.

The product complies with the RoHS.

WEEE Since infrared emitters are filament bulbs, they are **not** subject to EU Directive 2012/19/EU according to Art. 2(3c) and **not** subject to the UK Statutory Instrument 2013/3113 (WEEE) according to No. 7(c).

➔ Recycle infrared emitters or dispose of in accordance with the legal regulations.

11 EU/UKCA Declaration of Conformity

Excelitas Noblelight declares that this product complies with the following Directives:

Emitter voltage > 50 V AC/75 V DC

- EU Directives:**
- Low-voltage Directive
 - Ecodesign Directive
 - RoHS

- UK Statutory Instruments:**
- 2016/1101
 - 2010/2617
 - 2012/3032

Emitter voltage < 50 V AC/75 V DC

- EU Directives:**
- Ecodesign Directive
 - RoHS

- UK Statutory Instruments:**
- 2010/2617
 - 2012/3032

Complete Declarations of Conformity will be provided on request.

