

PGA Series of Single- and Multi-epi 905 nm Pulsed Semiconductor Lasers **High-Power Laser-Diode Family for Industrial Range Finding**

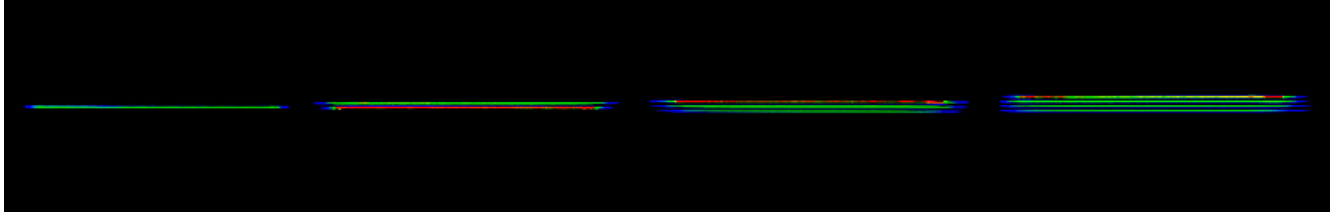

The PGA Series of pulsed semiconductor lasers are available in single, double, triple, or quadruple epi-cavity versions.

Excelitas Technologies' PGA Series of single- and multi-epi 905 nm pulsed semiconductor lasers consists of hermetically packaged devices having up to four active lasing cavities, which are epitaxially grown on a single GaAs substrate chip. This multi-cavity design multiplies the output power by the number of epi-layers. For example, the QPGA quad laser at 225 μm active layer, width which has four epitaxially grown lasing layers, delivers an output peak power >100 W and, by additionally stacking three quad chips into a single package, the usable device power even exceeds 300 W.

The laser chips of the PGA family feature stripe widths of 75 and 225 μm and come as single (PGA), double (DPGA), triple (TPGA), or quadruple (QPGA) epi-cavity version, which additionally can be stacked to further increase the output power.

The PGA series possesses a 25° beam divergence in the direction perpendicular to chip surface and a 10° beam spread within the junction plane. The power output shows an excellent stability over the full MIL specification temperature range. Structures are fabricated using metal organic chemical vapour deposition (MOCVD).

Recognizing that different applications require different packages, six standard package options are available, including the traditional stud designs as well as 5.6 and 9 mm CD packages and ceramic substrates. Since pulse widths in applications have decreased and optical coupling has become even more important, the newer packages – boasting reduced inductance and thinner, flatter windows – have gained popularity.

Additionally where fiber coupling applications are concerned, the transverse spacing of the EPI cavity active areas concentrates more optical power into a smaller geometry allowing for increased optical power coupling into optical fibers.

Key Features

- Doubling, tripling or quadrupling of the output power from a single epi-cavity
- Peak power >300 W for 3 physically stacked quad epi-cavity chips
- Extremely high reliability
- Proven in safety applications since early 1990s
- Range of single element and stacked devices
- Choice of 6 standard packages.
- 80% power retention at 85°C ambient
- Flexibility in customization for different applications
- Small emitting areas increases fiber coupled output
- RoHS compliant

Applications

- Laser range finding
- Laser safety curtains (laser scanning)
- Infrared night illumination
- Laser speed measurement (LIDAR)
- Automotive adaptive cruise control (ACC)
- Material excitation in medical and other analytical applications
- Weapon simulation

PGA Series of Single- and Multi-epi 905 nm Pulsed Semiconductor Lasers

High-Power Laser-Diode Family for Industrial Range Finding

PGA Pulsed Laser Family Selection Table

The following table lists the preferred chip and stacking options. For other configurations please inquire.

Device	Description	# of emitting stripes	Typical peak power	
			at 10 A, 100 ns 75 μm (3 mils) stripe width	at 30 A, 100 ns 225 μm (9 mils) stripe width
PGAx1	Single chip laser – Single epi-cavity	1	8 W	23W
DPGAX1	Single chip laser –Double epi-cavity	2	15 W	50W
TPGAX1	Single chip laser –Triple epi-cavity	3	23 W	75W
QPGAx1	Single chip laser –Quad epi-cavity	4	33 W	100W
TPGAX2	Double chip laser –Two stacked chips, triple epi-cavity	6	45 W	150W
QPGAx2	Double chip laser – Two stacked chips, quad epi-cavity	8	65 W	200W
QPGAx3	Triple chip laser – Three stacked chips, quad epi-cavity	12	95 W	300W

'x' = package type. Preferred package: S-type

Table 1: Maximum Ratings

Parameter	Symbol	Min	Max	Units
Peak reverse voltage	V_{RM}		2	V
Pulse duration	t_w		1	μs
Duty factor	du		0.1	%
Storage temperature	T_S	-55	105	$^{\circ}\text{C}$
Operating temperature	T_{OP}	-55	85	$^{\circ}\text{C}$
Soldering for 5 seconds (leads only)			+260	$^{\circ}\text{C}$

Table 2: Generic Electro Optical Specifications at 23 $^{\circ}\text{C}$

Parameter	Symbol	Min	Typ	Max	Units
Center wavelength of spectral envelope	λ_c	895	905	915	nm
Spectral bandwidth at 50% intensity points	$\Delta\lambda$		5		nm
Wavelength temperature coefficient	$\Delta\lambda/\Delta T$		0.25		nm/ $^{\circ}\text{C}$
Beam spread (50% peak intensity) parallel to junction plane	$\Theta_{ }$		10		degrees
Beam spread (50% peak intensity) perpendicular to junction	Θ_{\perp}		25		degrees

PGA Series of Single- and Multi-epi 905 nm Pulsed Semiconductor Lasers

High-Power Laser-Diode Family for Industrial Range Finding

Table 3: 75µm Stripe Width Family: Operating Characteristics at $T_{OP} = 23^{\circ}C$, $i_{FM} = 10A$, $t_W = 100ns$, $prf = 1kHz$

Parameter		PGA S1S03H	DPGA S1S03H	TPGA S1S03H	QPGA S1S03H	TPGA S2S03H	QPGA S2S03H	QPGA S3S03H	Units
Minimum Optical Power at i_{FM}	P_{Omin}	7	14	21	29	42	58	85	W
Typical Optical Power at i_{FM}	P_{Otyp}	8	16	24	31	45	62	90	W
# of Emitting stripes	-	1	2	3	4	6	8	12	
# of Laser chips		1	1	1	1	2	2	3	
Emitting area		75 X 1	75 X 5	75 X 10	75 X 15	75 X 175	75 X 200	75X 400	µm
Maximum Peak forward Current	i_{FM}	10	10	10	10	10	10	10	A
Typical lasing threshold current	i_{TH}	0.5	0.75	0.75	0.75	0.75	0.75	0.75	A
Typical Forward voltage ¹ at i_{FM}	V_F	3	7	10	13	20	26	39	V
Preferred Package		S, U	S, U	S, U	S, U	S, U	S, U	S, U	
Package Options		C, F, R, Y	C, F, R, Y	C, F, R, Y	C, F, R, Y	C, F, R, Y	C, F, R, Y	C, F, R, Y	

1. Excluding the voltage drop contribution due to the inductive element of the package

Table 4: 225µm Stripe Width Family Operating Characteristics at $T_{OP} = 23^{\circ}C$, $i_{FM} = 30A$, $t_W = 100ns$, $prf = 1kHz$

Parameter		PGA S1S09H	DPGA S1S09H	TPGA S1S09H	QPGA S1S09H	TPGA S2S09H	QPGA S2S09H	QPGA S3S09H	Units
Minimum Optical Power at i_{FM}	P_{Omin}	20	46	70	95	140	180	270	W
Typical Optical Power at i_{FM}	P_{Otyp}	23	50	75	100	150	200	300	W
# of Emitting stripes	-	1	2	3	4	6	8	12	
# of Laser chips		1	1	1	1	2	2	3	
Emitting area		225 X 1	225 X 5	225 X 10	225 X 15	225 X 175	225 X 200	225X 400	µm
Maximum Peak forward Current	i_{FM}	30	30	30	30	30	30	30	A
Typical lasing threshold current	i_{TH}	1.5	1.75	1.75	1.75	1.75	1.75	1.75	A
Typical Forward voltage ¹ at i_{FM}	V_F	4.5	9	12.5	20	26	38	57	V
Preferred Package		S, U	S, U	S, U	S, U	S, U	S, U	S, U	
Package Options		C, F, R, Y	C, F, R, Y	C, F, R, Y	C, F, R, Y	C, F, R, Y	C, F, R, Y	C, F, R, Y	

1. Excluding the voltage drop contribution due to the inductive element of the package

PGA Series of Single- and Multi-epi 905 nm Pulsed Semiconductor Lasers

High-Power Laser-Diode Family for Industrial Range Finding

Ordering Guide

	X	P	G	A	X	X	S	XX	H
Double active area	D								
Triple active area	T								
Quadruple active area	Q								
Pulsed		P							
905 nm wavelength			G						
± 10 nm spectral width				A					
Preferred S package					S				
Preferred Y package					Y				
Optional U package					U				
Optional C package					C				
Optional R package					R				
Optional F package					F				
Single chip stack						1			
Double chip stack						2			
Triple chip stack						3			
Stackable chip							S		
0.003" wide laser stripe (75 μm)								03	
0.009" wide laser stripe (225 μm)								09	
RoHS compliance									H

Electro-Optical Characteristics

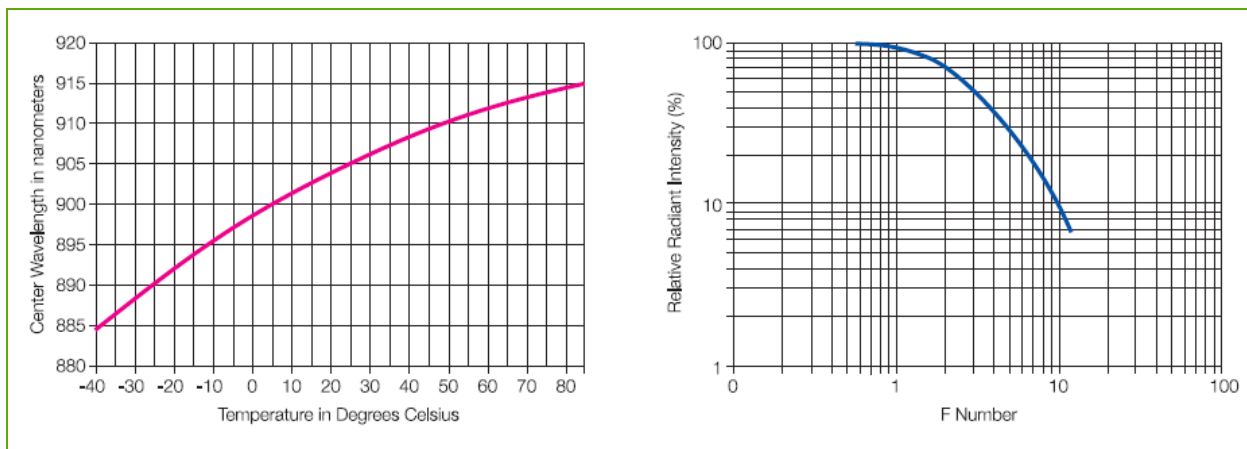
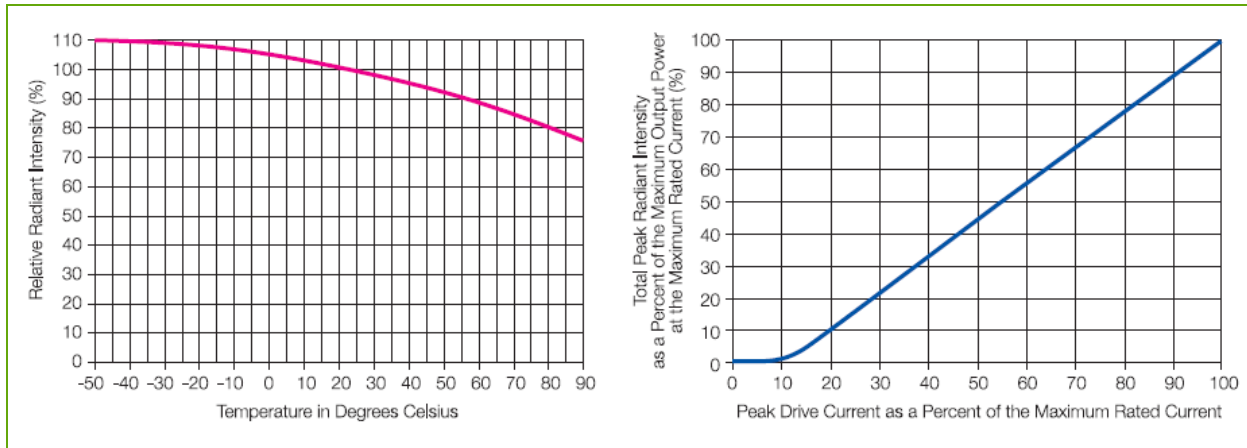

PGA Series of Single- and Multi-epi 905 nm Pulsed Semiconductor Lasers

High-Power Laser-Diode Family for Industrial Range Finding

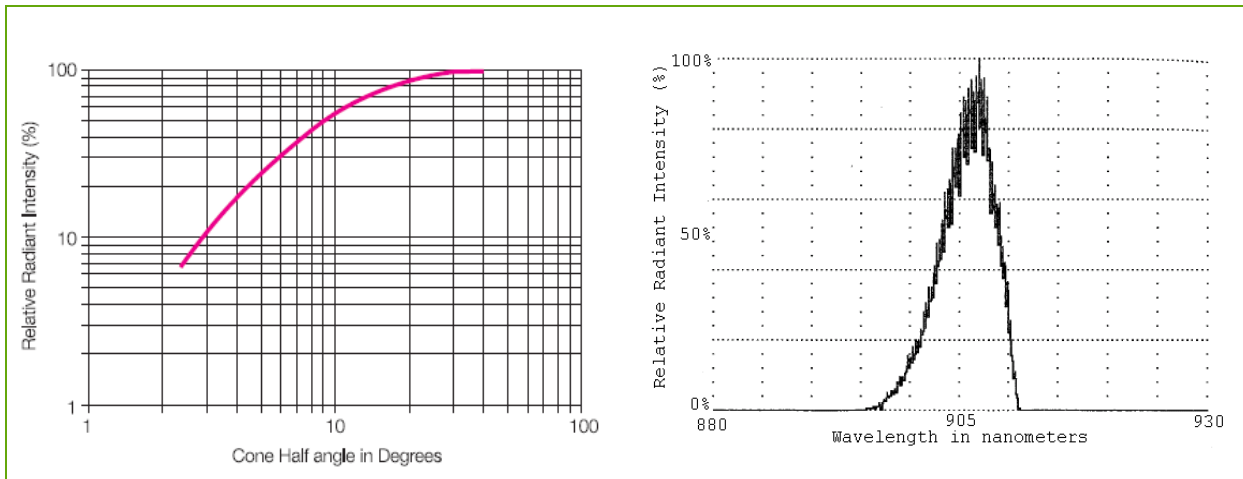

Figure 3

LEFT: Radiant Intensity vs. Half Angle

RIGHT: Spectral Distribution Plot

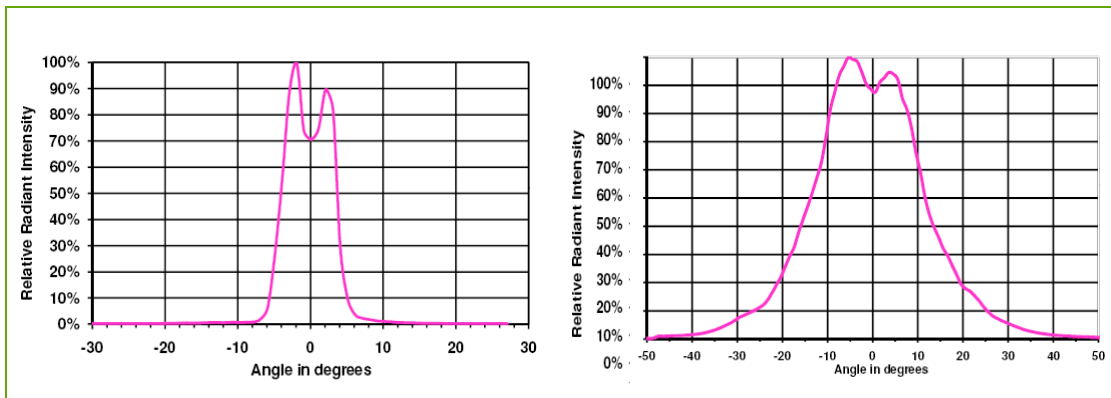

Figure 4

LEFT: Far Field Pattern Parallel to Junction Plane

RIGHT: Far Field Pattern Perpendicular to Junction Plan

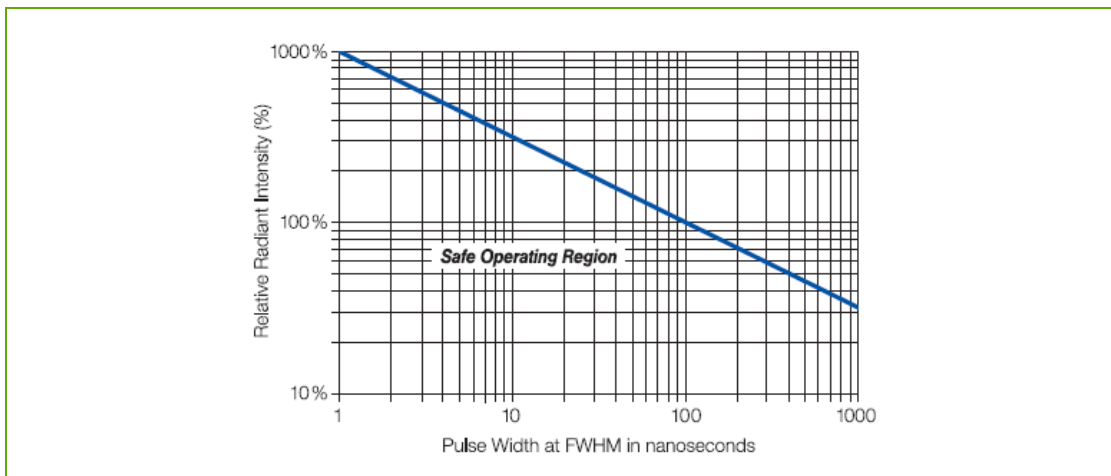

Figure 5

Radiant Intensity vs. Pulse Width for Safe Operation

PGA Series of Single- and Multi-epi 905 nm Pulsed Semiconductor Lasers

High-Power Laser-Diode Family for Industrial Range Finding

Package Drawings

<p>Technical drawing of VS-266R1 laser package. Dimensions include: 5.43 (0.210) total width, 3.00 (0.118) inner width, 4.70 (0.185) outer width, 3.86 (0.152) height, 2.6 (0.102) pin height, 0.46 (0.018) DIA pin diameter, 0.3 (0.012) base thickness, 2.54 DIA (0.100) mounting hole, and a 45° chamfer.</p>	<p>Photograph of the VS-266R1 laser package, showing a blue laser diode chip mounted on a metal base with two pins.</p>
<p>Technical drawing of VS-210R2 laser package. Dimensions include: 0.4 (0.016) top chamfer, 90° chamfer angle, 5.6 DIA (0.220) top diameter, 4.2 DIA (0.165) middle diameter, 1.0 (0.039) height, 1.7-1.0 DIA (0.067-0.039) bottom diameter, 3.55 DIA (0.140) bottom diameter, 2.32 (0.091) pin height, 1.2 (0.047) pin spacing, 6.5 (0.256) pin length, 2.0 DIA (0.078) mounting hole, 0.45 DIA (0.018) base diameter, 2.47 (0.097) base thickness, 0.250 (0.010) base diameter, and 0.4 (0.016) bottom diameter.</p>	<p>Photograph of the VS-210R2 laser package, showing a laser diode chip mounted on a metal base with three pins.</p>
<p>Technical drawing of VS-262R1 laser package. Dimensions include: 5.84 (0.230) total width, 6.35 (0.250) height, 4.47 (0.176) pin height, 7.62 (0.300) pin length, 30.5 (1.2) total length, 0.46 (0.018) DIA pin diameter, 3.00 (0.118) inner width, 4.70 (0.185) outer width, 3.54 (0.139) base diameter, 8-32 UNC THREAD, and 0.3 (0.012) base thickness.</p>	<p>Photograph of the VS-262R1 laser package, showing a laser diode chip mounted on a metal base with a threaded pin.</p>
<p>Technical drawing of VS-214R1 laser package. Dimensions include: 0.4 (0.016) top chamfer, 9.0 DIA (0.354) top diameter, 7.9 DIA (0.310) middle diameter, 3.0 DIA (0.117) bottom diameter, 6.4 DIA (0.252) bottom diameter, 1.0 (0.039) height, 0.25 (0.010) pin height, 3.15 (0.124) pin length, 1.5 (0.059) pin spacing, 14.0 (0.551) pin length, 2.5 DIA (0.098) mounting hole, 0.45 DIA (0.018) base diameter, 3.95 (0.155) base diameter, and 0.4 (0.016) bottom diameter.</p>	<p>Photograph of the VS-214R1 laser package, showing a laser diode chip mounted on a metal base with three pins.</p>

Package S:

Pin out 1. LD Anode (+), 2. LD Cathode (-)
Case, Inductance
5.2 nH

Package U:

Pin out 1. LD Anode (+), 2. NC, 3. LD Cathode (-)
Case, Inductance 5.0 nH

Package C:

Pin out: LD Cathode (-)
Case, Pin LD Anode (+), Inductance 12 nH

Package R:

Pin out 1. LD Anode (+), 2. NC, 3. LD Cathode (-)
Case, Inductance 6.8 nH

PGA Series of Single- and Multi-epi 905 nm Pulsed Semiconductor Lasers

High-Power Laser-Diode Family for Industrial Range Finding

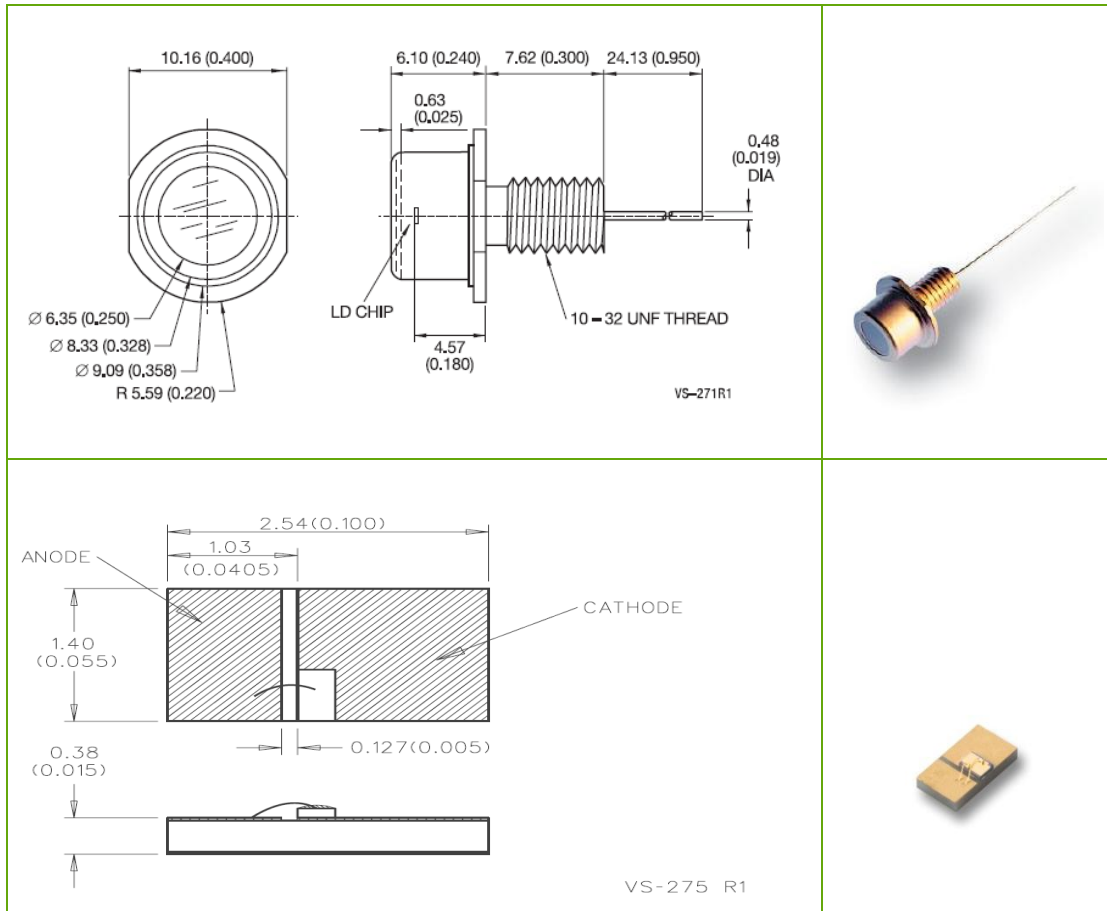

Package F:

Pin out: LD Cathode (-) Case, Pin LD Anode (+), Inductance 11 nH

Package Y:

Pin out 1. LD Cathode (-) chip bottom, 2. LD Anode (+) chip top, Inductance 1.6 nH

Operating Conditions

The laser is operated by pulsing current in the forward bias direction.

The Excelitas warranty applies only to devices operated within the maximum rating, as specified. Exceeding these conditions is likely to cause permanent "burn off" damage to the laser facet and consequently a significant reduction in optical power.

Operating the devices at increased duty cycles will ultimately and irreparably damage the crystal structure due to internal heating effects. Diodes are static sensitive and suitable precautions should be taken when removing the units from their antistatic containers. Circuits should be designed to protect the diodes from high current and reverse voltage transients. Voltages exceeding the reverse breakdown of the semiconductor junction are particularly damaging and have been shown to cause degradation of power output. Although the devices will continue to perform well at elevated temperatures for some thousands of hours, defect mechanisms are accelerated.

Optimum long term reliability will be attained with the semiconductor at or below room temperature. Adequate heat sinking should be employed, particularly for the larger stacks and when operated at maximum duty factor.

Forward Voltage

The forward voltage of the device is a combination of: a static voltage drop resulting from band gaps and material characteristics, a dynamic series resistance resulting from the contact area dimensions, the resistivity of the contact layers, and the inductive voltage drop of the package. Voltages due to the inductive elements are additional and, therefore, are considered separately since they depend on the package inductance, the pulse rise time and the peak current.

PGA Series of Single- and Multi-epi 905 nm Pulsed Semiconductor Lasers

High-Power Laser-Diode Family for Industrial Range Finding

Package Inductance

When narrow pulse widths are required, the system designer must take care that circuit inductance is kept to a minimum (note inductance on package list). Using the lower inductance packages will reduce the peak voltage required to obtain the desired drive current.

For example, to obtain approximate Gaussian pulse shapes for the “C” and “U” packages:

1. DPGAC1S12H:

$$t_w = 40 \text{ ns } P_{rr} = 25 \text{ kHz, } t_r = 20 \text{ ns,}$$

$$i_r = 60 \text{ A, } L_{CPKG} = 12 \text{ nH}$$

$$V_L = L_{PKG} \times di/dt$$

$$V_{CPKG} = 12 \times 10^{-9} \times 60/20 \times 10^{-9} = 36 \text{ V}$$

2. DPGAU1S12H:

$$t_w = 40 \text{ ns } P_{rr} = 25 \text{ kHz, } t_r = 20 \text{ ns,}$$

$$i_r = 60 \text{ A, } L_{UPKG} = 5 \text{ nH}$$

$$V_L = L_{PKG} \times di/dt$$

$$V_{UPKG} = 5 \times 10^{-9} \times 60/20 \times 10^{-9} = 15 \text{ V}$$

Note: These voltage drops are merely to overcome the inductance of the package and do not include the series package and chip static resistances.

Other circuit elements typically increase voltage requirements to $3 \times V_{PKG}$, therefore the location of components to minimize lead length is critical.

For Your Safety

Laser Radiation:

Under operation, these devices produce invisible electromagnetic radiation that may be harmful to the human eye. To ensure that these laser components meet the requirements of Class IIIb laser products, they must not be operated outside their maximum ratings. Power supplies used with these components must be such that the maximum peak forward current cannot be exceeded. It is the responsibility of the user incorporating a laser into a system to certify the Class of use and ensure that it meets the requirements of the ANSI or appropriate authority.

Further details may be obtained in the following publications:

21CFR 1040.10 – “Performance Standards for Light Emitting Products (Laser Products)”

ANSI Z136.1 – “American National Standard for Safe use of Lasers”

IEC 60825-1 – “Safety of Laser Products”

PGA Series of Single- and Multi-epi 905 nm Pulsed Semiconductor Lasers

High-Power Laser-Diode Family for Industrial Range Finding

Ordering Information:

The “preferred package” options on the list will normally be offered at lower cost and with shorter delivery times. To keep the costs down the standard devices are tested and burned-in under standard conditions.

While the devices are warranted over the entire specification, for a quantity purchase, customers are advised to discuss their requirements in advance so that any special test needs can be accommodated and yields optimized.

Excelitas has been routinely supplying lasers for military applications since the early 1990s. These diodes benefit from long years of experience from screened laser diodes to European and North American military specifications. Though the commercial products are not continuously screened, they are designed to meet demanding environmental conditions.

Typical qualification of these parts would include:

- High Temperature Storage
- Hermetic Seal
- Thermal Shock
- Random Vibration
- Acceleration
- Mechanical Shock

Excelitas is pleased to assist with advice and test procedures for your specific environmental needs.

RoHS Compliance

This series of laser diodes are designed and built to be fully compliant with the European Union Directive 2002/95/EC – Restriction of the use of certain Hazardous Substances in Electrical and Electronic equipment.



Warranty

A standard 12-month warranty following shipment applies. Any warranty is null and void if the package window has been opened.

About Excelitas Technologies

Excelitas Technologies is a global technology leader focused on delivering innovative, customized solutions to meet the lighting, detection and other high-performance technology needs of OEM customers.

From analytical instrumentation to clinical diagnostics, medical, industrial, safety and security, and aerospace and defense applications, Excelitas Technologies is committed to enabling our customers' success in their specialty end-markets. Excelitas Technologies has approximately 3,000 employees in North America, Europe and Asia, serving customers across the world.

Excelitas Technologies
22001 Dumberry Road
Vaudreuil-Dorion, Quebec
Canada J7V 8P7
Telephone: (+1) 450.424.3300
Toll-free: (+1) 800.775.6786
Fax: (+1) 450.424.3345
Detection.na@excelitas.com

**Excelitas Technologies
GmbH & Co. KG**
Wenzel-Jaksch-Str. 31
D-65199 Wiesbaden
Germany
Telephone: (+49) 611 492 430
Fax: (+49) 611 492 165
detection.europe@excelitas.com

Excelitas Technologies Singapore, Pte. Ltd.
1 Fusionopolis Walk, #11-02
Solaris South Tower
Singapore 138628
Telephone: (+65) 6775 2022 (Main)
Telephone: (+65) 6770 4366 (Customer Service)
Fax: (+65) 6778 1752
detection.asia@excelitas.com



For a complete listing of our global offices, visit www.excelitas.com/locations

© 2013 Excelitas Technologies Corp. All rights reserved. The Excelitas logo and design are registered trademarks of Excelitas Technologies Corp. All other trademarks not owned by Excelitas Technologies or its subsidiaries that are depicted herein are the property of their respective owners. Excelitas reserves the right to change this document at any time without notice and disclaims liability for editorial, pictorial or typographical errors.