

OmniCure®

UV Bonding • In Control

R2000 Radiometer

UV/VISIBLE RADIOMETER

250 – 1000 nm

USER GUIDE

Excelitas Canada Inc.

2260 Argentia Road

Mississauga (ON)

L5N 6H7 Canada

+1 905.821.2600

www.excelitas.com

035-00310R Rev. 3

USER GUIDE

035-00310R

Excelitas Canada Inc. 2022

All rights reserved

No part of this publication may be reproduced, transmitted, transcribed, stored in a retrieval system or translated into any language in and form by any means without the prior written consent of Excelitas Canada Inc. every effort has been made to ensure information in this manual is accurate, however, information in this manual is subject to change without notice and does not represent a commitment on the part of the authors.

Trademarks:

OmniCure® is a trademark of Excelitas Canada Inc. All rights reserved. All other product names are trademarks of their respective owners. All product or software photos shown are for reference only and are subjected to change without notice.

Made in Canada. Doc. No. 035-00310R

R2000 Control Panel Software

Minimum Computer Specifications:

300+ MHz processor (Pentium or equivalent)

Windows 98, 2000 or XP

32 Mb RAM

10 Mb for Software Installation

20 Mb for Data Storage

SVGA video 800x600 resolution

One available RS-232 Port

Table of Contents

| | | |
|----------|--|-----------|
| 1 | INTRODUCTION | 6 |
| 2 | CONTROL FUNCTIONS & FEATURES | 7 |
| 3 | FAMILIARIZING YOURSELF WITH THE R2000 RADIOMETER | 9 |
| 4 | USING THE R2000 RADIOMETER | 13 |
| 4.1 | <i>TURNING THE R2000 RADIOMETER ON</i> | 13 |
| 4.2 | <i>CALIBRATION</i> | 13 |
| 4.3 | <i>USING LIGHT GUIDE ADAPTERS</i> | 14 |
| 4.4 | <i>USING NON-STANDARD SIZE LIGHT GUIDES</i> | 15 |
| 4.5 | <i>CONNECTING TO A LIGHT SOURCE</i> | 16 |
| 4.6 | <i>MEASURING IRRADIANCE</i> | 16 |
| 4.7 | <i>MEASURING POWER</i> | 16 |
| 4.8 | <i>MEASURING IN RELATIVE MODE</i> | 17 |
| 4.9 | <i>MEASURING IN ABSOLUTE MODE</i> | 17 |
| 4.10 | <i>CONNECTING EXTERNAL RADIOMETER DEVICES</i> | 18 |
| 4.11 | <i>STORING DATA</i> | 19 |
| 4.12 | <i>INTERFACING WITH COMPATIBLE OMNISCURE UV CURING SYSTEMS</i> | 20 |
| 4.13 | <i>CALIBRATING COMPATIBLE OMNISCURE UV CURING SYSTEMS</i> | 20 |
| 4.14 | <i>USING THE R2000 RADIOMETER WITH A PC</i> | 21 |
| 5 | GLOSSARY OF SYMBOLS AND SAFETY PRECAUTIONS | 34 |
| 6 | TROUBLESHOOTING | 36 |
| 6.1 | <i>DISPLAY INDICATES 'ADC' MESSAGE</i> | 36 |
| 6.2 | <i>DISPLAY INDICATES 'BAT' MESSAGE</i> | 36 |
| 6.3 | <i>DISPLAY INDICATES 'CAL' MESSAGE</i> | 37 |
| 6.4 | <i>DISPLAY INDICATES 'ERR' MESSAGE</i> | 37 |
| 6.5 | <i>DISPLAY INDICATES 'LG' MESSAGE</i> | 38 |
| 6.6 | <i>DISPLAY INDICATES 'LGA' MESSAGE</i> | 38 |

| | | |
|-----------|--|-----------|
| 6.7 | DISPLAY INDICATES 'LOC' MESSAGE | 39 |
| 6.8 | DISPLAY INDICATES 'CLO' MESSAGE..... | 39 |
| 7.1 | OPTICAL | 40 |
| 7.2 | ELECTRICAL..... | 41 |
| 7.3 | MECHANICAL | 41 |
| 7.4 | RS-232 COMMUNICATION COM PORT CONFIGURATION: 41 | |
| 7.5 | ENVIRONMENTAL CONDITIONS..... | 42 |
| 8 | REGULATORY COMPLIANCE | 43 |
| 8.1 | SAFETY AND ELECTROMAGNETIC COMPATIBILITY: | 43 |
| 8.2 | CHINA ROHS | 45 |
| 8.3 | WEEE DIRECTIVE..... | 46 |
| 9 | ACCESSORIES | 47 |
| 10 | WARRANTY | 49 |
| 11 | CONTACT INFORMATION..... | 51 |

1 Introduction

Congratulations on your purchase of the R2000 Radiometer. This radiometer includes revolutionary technology that elevates the performance and accuracy of hand held radiometers to new heights. It joins the Excelitas Canada Inc. family of spot cure and illumination systems, offering the same high level of innovation, quality and reliability that customers have come to expect from Excelitas Canada Inc.

At the heart of the R2000 Radiometer are two proprietary systems: a non-imaging optical interface that virtually eliminates measurement variation caused by radiance and intensity variations in the light source; and a flat response optical detector system that responds to energy at all wavelengths between 250 and 1000 nm. The result is a hand held, robust and versatile radiometer with accuracy unmatched in the industry.

The R2000 Radiometer provides unique features when combined with the OmniCure 2000 UV Visible Spot Curing System.

2 Control Functions & Features

| Features | Benefits |
|---|--|
| Provides accurate broadband measurements between 250-1000nm | Versatile measurement capability suitable for many different light Sources |
| Measures power or irradiance | Allows for industry specific measures |
| Optical interface collects light over a large area | Eliminates beam intensity and radiance dependence |
| Auto-ranging | Maintains precision over full range |
| Real-time Mode | Allows for tracking of a varying signal |
| Relative Mode | References all measurements to a pre-set value |
| Absolute Mode | References all measurements to NIST traceable units |
| Fits standard light guides (2mm, 3mm, 5mm, 8mm) | Automatically senses light guide diameters & accommodates industry standard light delivery systems |

| Features | Benefits |
|--|-------------------------|
| Designed to meet IEC, Canadian and US Standards and CE marking | Ready for use worldwide |

| | |
|---|--|
| requirements | |
| Calibration traceable to NIST | Quality assurance |
| Calibration period of 12 months | Lower cost of operation |
| Auto turn off | Extends battery life and makes operation easier |
| RS-232 connection to OmniCure Series of UV Curing Systems | Allows calibration and setup of OmniCure Series of UV Curing Systems |
| RS-232 connection to PC | Provides PC GUI and electronic calibration of the radiometer |
| PC GUI | Allows full control of all features and functionality from a PC |
| Memory | Stores the current reading for future retrieval by PC software |

3 Familiarizing yourself with the R2000 Radiometer



The R2000 Radiometer comes complete with:

- 3mm (Red), 5mm (Blue) and 8mm (Green) Light Guide Adapters
- 6' Phono-style cable (RS-232)
- 6' 9-Pin style cable (RS-232)
- CD with GUI software and programming notes
- Carrying case

Light Guide Adapter

Interfaces Excelitas Canada Inc. standard size light guides to the optical input port to promote accurate light delivery into the R2000 Radiometer.

The R2000 Radiometer is able to detect the output dimension of the light guide depending on the colour of the light guide adapter inserted.

Thumbscrew

Used to secure the light guide adapter to the light guide.

Remote Input Connector

A 6-Pin Mini-DIN connector that allows the R2000 Radiometer to interface with optional external cure site and cure ring radiometers.

RS-232 Connector

A 'stereo-phono' style connector that connects the R2000 Radiometer to a PC or compatible OmniCure UV Curing Systems.

LCD Display

The display is a 3.5 digit, 7-segment LCD display.

Front Keypad

The front keypad is comprised of 6 independent membrane-style switches,

ON

Pressing this button will turn the R2000 Radiometer on.

RELATIVE / ABSOLUTE

Each press of this button toggles between relative and absolute mode. The default setting is Absolute mode.

The Relative mode displays measurements as a percentage of a reference value.

OmniCure CAL

Used to calibrate and set up compatible OmniCure UV Curing Systems to a specified irradiance.

POWER / IRRAD

Each press of this button toggles between Power or Irradiance measurements.

EXTERNAL

Enables the R2000 Radiometer to detect and measure external radiometer devices when connected through the remote Input connector.

STORE

This feature is used to save measurement data into a data log memory for future retrieval from a PC.

The data stored is

- Date / Time
- Irradiance and Power
- Serial Number – (OmniCure UV Curing Systems)
- External input channel

Rubber Boot

A protective, flexible cover that allows the radiometer to stand upright on a flat surface. The rubber boot is optional and can be removed when not desired.

When the boot is utilized, the RS-232 connector and Remote Input connector are accessible by lifting flap on the right side of the boot.

Acronyms, Abbreviations and Definitions

| | |
|------------|---------------------------------|
| <i>PC</i> | <i>Personal Computer</i> |
| <i>GUI</i> | <i>Graphical User Interface</i> |

4 Using the R2000 Radiometer

4.1 Turning the R2000 Radiometer ON

The R2000 Radiometer is fitted with an ON switch located on the front keypad. Press and release the button. All segments on the display illuminate for 1 second.

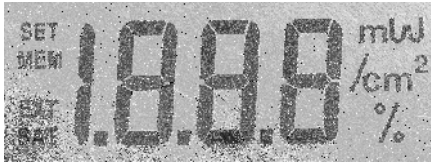

Note: If a light guide adapter is installed in the optical port, the display will flash the diameter of the light guide adapter for 3 sec.

Note: The R2000 Radiometer will automatically turn OFF after 1 minute if the unit does not detect any optical input, RS232 communication, or keypad activity.

Note: The R2000 Radiometer remains in the same measurement mode that it was in after an occurrence of an automatic power off.

4.2 Calibration

Should the CAL message appear on the display immediately following the R2000 Radiometer being turned ON, it indicates that the unit requires calibration. The message remains illuminated for 5 seconds.



It is recommended that the R2000 Radiometer be calibrated every 12 months to ensure valid measurements. The calibration is traceable to NIST and a calibration certificate is included at each calibration cycle.

Calibration is authorized only by a certified Excelitas Technologies service center. When calibration is due contact Excelitas Technologies for a return authorization number. Refer to Section 9.0.

4.3 Using Light Guide Adapters

Each R2000 Radiometer includes two standard light guide adapters, 3mm (RED), 5mm (BLUE) and 8mm (GREEN).

One other size is available: 2mm (GOLD)

Note: If the R2000 Radiometer is on when the adapter is installed, the display will flash the diameter of the light guide adapter for 3 sec.

Insert the light guide adapter into the optical input port to the end of its travel. A click should be heard that indicates positive insertion of the light guide adapter.

Insert the light guide into the light guide adapter to the end of its travel. Hand-tighten the thumb screw to secure the light guide into place. Note: The use of a tool to tighten the thumbscrew is not recommended. Over-tightening could cause damage to the light guide.

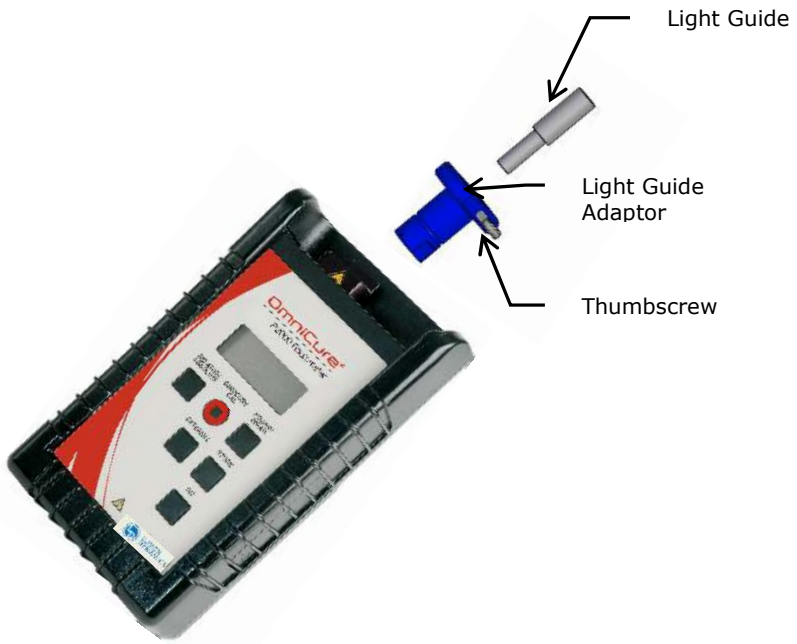

When the light guide adapter is secured it can remain attached to the light guide if the light guide is removed.

To confirm which size light guide is inserted press the ON button simultaneously with the POWER/IRRAD button. The display will show the diameter of the light guide in mm (i.e. 5.0).

4.4 Using Non-Standard Size Light Guides

In order to use non-standard size light guides with the R2000 Radiometer a custom light guide adapter is required. Contact Excelitas Canada Inc. for further details.

Note: The diameter of the light guide must be entered in the PC software before the light guide is used with its custom adapter.

4.5 Connecting to a Light Source

Connect a light guide with corresponding light guide adapter into the optical input port on the R2000 Radiometer. Turn light source ON. Always turn light source OFF before removing light delivery from the R2000 Radiometer. Refer to Section 5 for warnings and safety precautions.

4.6 Measuring Irradiance

When measuring irradiance, the display will show the measurement in either mW/cm^2 or W/cm^2 .



If the display is not showing the “ W/cm^2 ”, it indicates that the R2000 Radiometer is in Power mode. Simply press the POWER/IRRAD keypad button to toggle into irradiance mode.

The R2000 Radiometer automatically detects the size of the light guide that is inserted, calculates the irradiance and displays the measurement.

4.7 Measuring Power

When measuring power, the display will show the measurement in either mW or W .



If the display is showing “ W/cm^2 ”, press the POWER/IRRAD keypad to toggle into Power mode.

4.8 Measuring in Relative Mode

The Relative mode displays measurements as a percentage of a reference value. The reference is the power at the point of entering Relative mode.

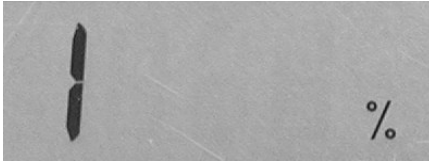

Select either Power or Irradiance mode from the keypad.

Adjust the optical source to the desired reference level, and then press the Relative/Absolute button. The R2000 Radiometer will toggle to Relative mode. All subsequent measurements will be displayed as a percentage of the reference.

A reading of “100%” indicates that the current measurement is the same value as the reference. A reading of “50%” indicates that the current measurement is half of the initial reference measurement. A reading of “200%” indicates that the current measurement is double of the initial reference.

Inserting a light guide from a different source will provide a measurement that is relative to the initial reading as described above.

4.9 Measuring in Absolute Mode

When in Absolute mode, the R2000 Radiometer displays the reading as power or irradiance, depending on which mode is selected.



4.10 Connecting External Radiometer Devices

To use the R2000 Radiometer with optional Cure Site and Cure Ring Radiometers, plug the 6-pin Mini-DIN style cable attached to the external device(s) into the Remote Input connector on the side of the R2000 Radiometer. External radiometer devices are available from Excelitas Canada Inc. as custom ordered items.

Press the EXTERNAL keypad button. The display will show the EXT icon and a number (starting at 1), that corresponds to the external radiometer sensor being detected. This number is shown for a few seconds and then the display shows the corresponding measurement of that device.

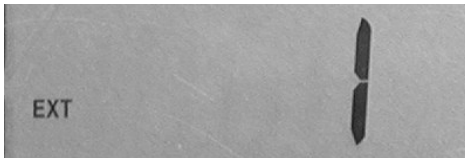

If multiple devices are connected each press of the EXTERNAL keypad button will increment to the next external device before returning back to internal mode. This is indicated on the display when the EXT icon is no longer illuminated.

The measurement mode is dependent on the type of sensor the external device has. For example, the R2000 Radiometer will only measure Irradiance when an external radiometer device is only able to measure Irradiance.

The Power mode becomes disabled and the display will show a 'Loc' message if the user tries to toggle into Power mode.

The same is true for sensors that measure only Power; the Irradiance mode will not be accessible and the display will show a 'Loc' message.

The following illustrates the use of the EXTERNAL feature with four external radiometer devices.

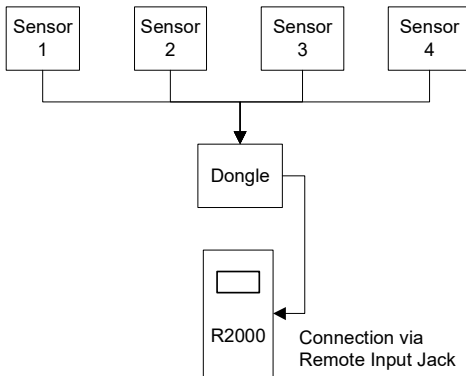

With each press of the EXTERNAL keypad button, the display will show,

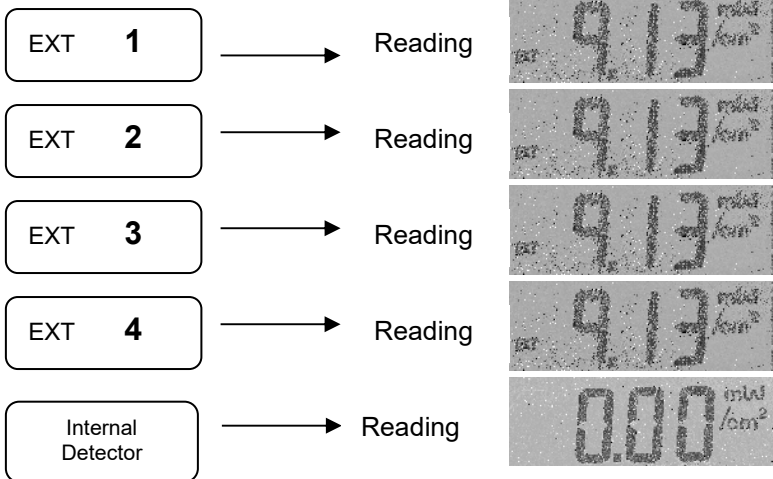

4.11 Storing Data

The R2000 Radiometer is able to store measurements based on what is being detected at the time the STORE button is pressed.

When the STORE button is pressed the display shows the 'MEM' icon and a number (starting at 1), that corresponds to the

number of stored readings. The number will increment each time STORE is pressed and the measurement will be stored.

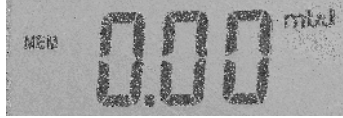
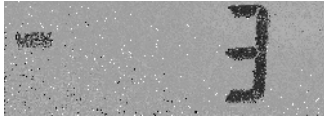

The STORE feature is generally used when the R2000 Radiometer will be connected to a PC via the RS-232 connector. When connected the stored readings are downloaded into a Data Log as seen on the R2000 Control Panel (via the GUI software provided). The stored readings can only be viewed by downloading to a PC. Once a reading has been stored, it can not be viewed on the R2000 Radiometer display.

4.12 Interfacing with Compatible OmniCure UV Curing Systems

Refer to the OmniCure Curing System User Guide.

The R2000 Radiometer is equipped with one I/O port for communication with compatible OmniCure curing systems. When connected, the R2000 Radiometer is able to calibrate the OmniCure SERIES 2000 UV Curing System and set the irradiance to a specific level.

To interface via the RS-232:

Plug the phono-style cable into the RS-232 connector located on the side of the unit and to the Audio Jack connector located on the front panel side of the OmniCure UV Curing System. The cable supplied is six feet in length.

4.13 Calibrating Compatible OmniCure UV Curing Systems

To initiate a calibration operation, press the OmniCure CAL button. The 'SET' icon will flash and the display will indicate the current set point.

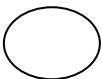



When the keypad is released a series of dashes '----' will illuminate across the display which indicates that the set point is being communicated to the OmniCure UV Curing system and calibration is being performed. Once the dashes cease to display the calibration cycle is complete.

If the SET 'Err' message appears it indicates that the calibration did not get completed. The calibration must be repeated.

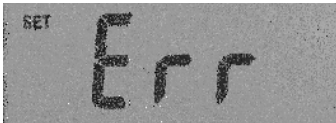

Holding the OmniCure CAL button for 5 seconds will store the current optical input into the radiometer's set point (this feature can be enabled or disabled via PC).

The SET icon will cease to flash, while remaining illuminated. The set point can be also be programmed by the PC.

4.14 Using the R2000 Radiometer with a PC

The following are the minimum requirements for a PC to be used with the R2000 Control Panel software:

- 300+ MHz recommended Pentium or equivalent processor
- 32 MB RAM
- 10 MB available storage for software installation
- 20MB additional storage (suggested) for your data files
- SVGA video 800 X 600 resolution, 8-bit color (16-bit color or better recommended)
- Available RS-232 COM port

Operating System Requirements:

Microsoft Windows® 95, 98, NT, 2000, ME or XP

The R2000 Radiometer comes complete with a CD that includes the R2000 Control Panel software that allows the user to operate and control the Radiometer from a PC.

Installing the R2000 Control Panel Software

- 1) Turn on the PC to be used with the R2000 Radiometer.
- 2) Shut down any other Windows programs currently in use
- 3) Insert the CD supplied with the R2000 Radiometer in the CD-ROM drive of your PC
- 4) Right-click your mouse on the Windows Start button and select Explore
- 5) Left-click on Explore and select the applicable CD drive
- 6) Double click on SETUP.EXE
- 7) Follow the setup instructions as they appear by clicking “next” each time the user prompt appears, until the installation has been completed and “finish” appears. Click on “finish” to complete the installation.
- 8) To access the control panel software program, click on the Windows Start menu and select: programs/ EXFO ►/ R2000 Control Panel. A screen with a title bar displaying “R2000 Control Panel” will appear.

Click on Connect at the top of the screen. The R2000 Control Panel will open when there is a successful connection. This should take no more than a few seconds.



As long as there is a connection between the PC and the Radiometer, data is automatically downloaded to the PC.

A 9-pin serial cable is provided with each R2000 Radiometer.

If a problem connecting occurs, a 'No response from radiometer....' Error may be displayed. If this occurs click 'OK' and check the R2000 Radiometer. Press the ON keypad button as necessary and try connecting again.

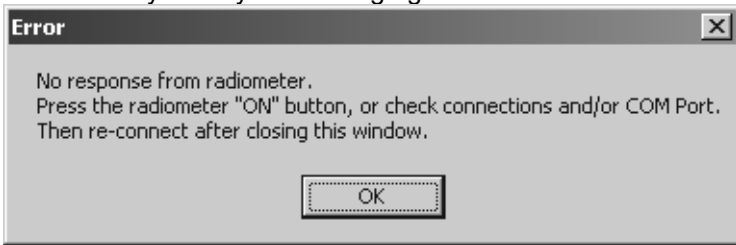

If a problem connecting occurs, the PC may display a 'Failed to open COM port' message. Click 'OK'.



Select from the File pull down menu – COM Ports. Ensure that the applicable COM port is checked and cable is connected to corresponding plug. Try connecting again.

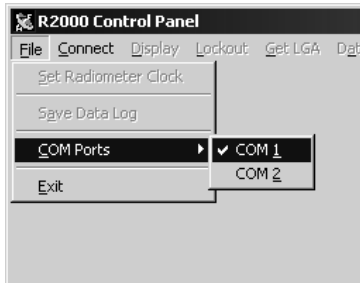

Note: This error may also appear if another program is running that is using the COM port that has been selected.

The following illustrates the R2000 Control Panel:

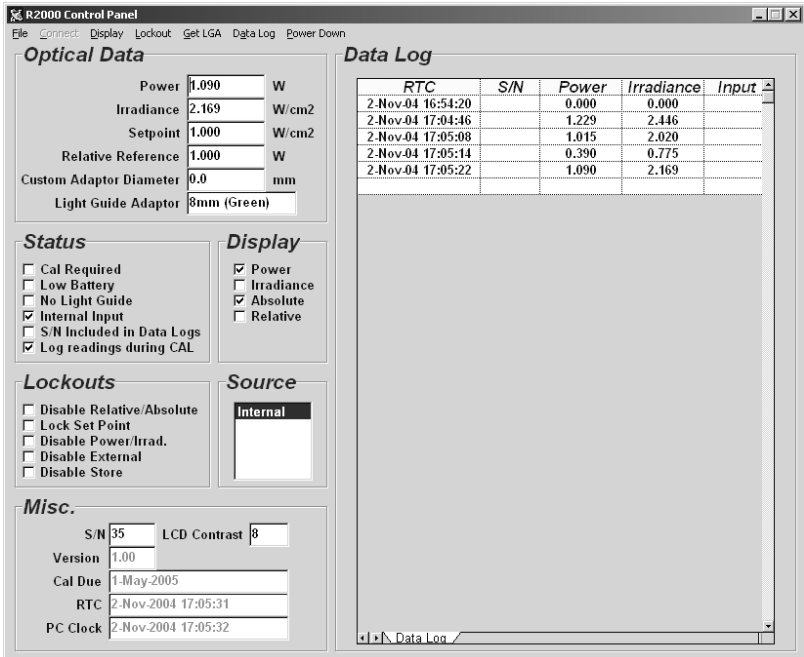

Based on the settings and data being read from the R2000 Radiometer, the information will display in the respective areas of the Control Panel. Some data is user-defined such as:

- Set Point
- Relative Reference
- Custom Adapter Diameter
- LCD Contrast

Note: When data is entered into a user-defined field the background colour of the field content changes to yellow. To transfer the number into the R2000 Radiometer, press the

ENTER key. If successful, the background reverts to the default colour.

If the transfer fails, the background colour reverts to the default colour but the foreground colour becomes red. A dialogue box will appear indicating that the request failed. Click OK to continue.

The **Optical Data** frame displays a combination of real-time data as it pertains to readings being taken from the R2000 Radiometer as well as user-defined fields.

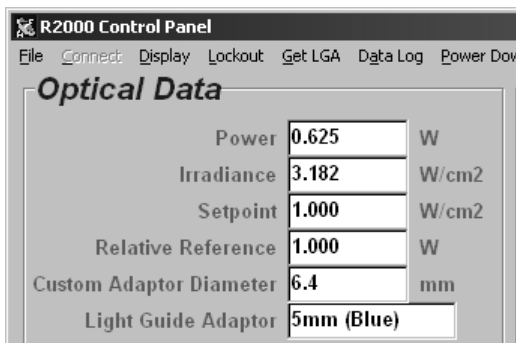

| Optical Data | | |
|-------------------------|------------|-------------------|
| Power | 0.625 | W |
| Irradiance | 3.182 | W/cm ² |
| Setpoint | 1.000 | W/cm ² |
| Relative Reference | 1.000 | W |
| Custom Adaptor Diameter | 6.4 | mm |
| Light Guide Adaptor | 5mm (Blue) | |

Power – Displays real-time data as it pertains to readings being taken from the R2000 Radiometer. This displays as either mW or W.

Irradiance – Displays real-time data as it pertains to readings being taken from the R2000 Radiometer. This displays as either mW/cm² or W/cm².

Light Guide Adaptor – Displays the diameter and colour of the light guide adapter being detected by the R2000 Radiometer.

Setpoint – User defined; enter the desired irradiance that will be used to set the compatible OmniCure UV Curing System after the OmniCure CAL button is pressed.

Relative Reference – User defined; enter the desired power reference to be used in Relative mode.

Custom Adapter Diameter – User defined; when using a non-standard light guide with the R2000 Radiometer enter the applicable diameter of the customized light guide adapter. This information must be entered before the light guide is used into the R2000 Radiometer

Light Guide Adaptor – Displays the diameter and colour of the light guide adapter being detected from the R2000 Radiometer. The **Misc.** frame displays a combination of real-time data as it pertains to readings being taken from the R2000 Radiometer as well as user-defined fields.

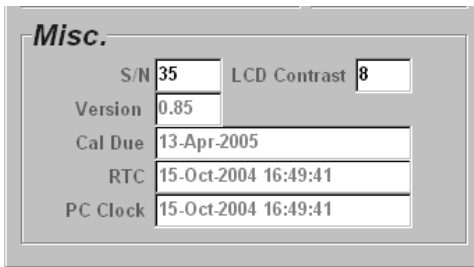

| | |
|--------------|----------------------|
| Misc. | |
| S/N | 35 |
| LCD Contrast | 8 |
| Version | 0.85 |
| Cal Due | 13-Apr-2005 |
| RTC | 15-Oct-2004 16:49:41 |
| PC Clock | 15-Oct-2004 16:49:41 |

S/N – Displays serial number of the R2000 Radiometer.

LCD Contrast – User defined; indicates level of contrast of LCD Display on R2000 Radiometer; 0 being the darkest and 15 being the lightest.

Version – Displays software version resident on R2000 Radiometer

Cal Due - Displays when next recommended calibration is due.

RTC (Real-Time-Clock) - Displays date and time based on internal clock on R2000 Radiometer.

PC Clock - Displays date and time according to PC clock.

If the RTC date/time stamp is not the same as the PC clock use the Set R2000 Radiometer Clock function under the File menu to synchronize.

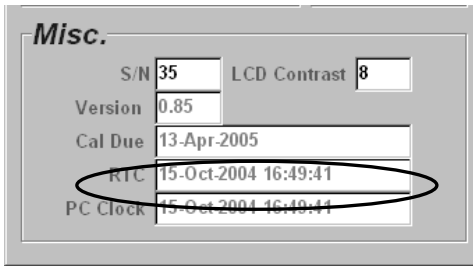
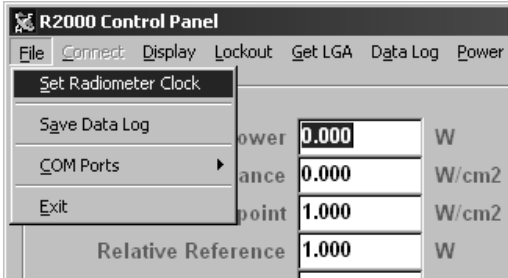

Status

The Status frame indicates the applicable status modes of the R2000 Radiometer.

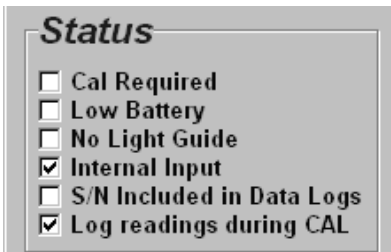

Cal Required – When checked indicates that the R2000 Radiometer is past its recommended calibration date. This is

equivalent to the 'CAL' message that appears on the R2000 Radiometer's display.

Low Battery – When checked indicates that the battery is low and should be replaced. This is equivalent to the 'BAT' message that appears on the R2000 Radiometer's display.

No Light Guide – When checked indicates that the R2000 Radiometer is not detecting a light guide. This is equivalent to the 'LG' message that appears on the R2000 Radiometer's display.

Internal Input – This box will be checked when Internal is highlighted in the Source frame. This indicates that optical input is being received from the optical port on the R2000 Radiometer.

S/N Included in Data Logs – When checked indicates that the serial number of the compatible OmniCure UV Curing System will be included in the Data Log.

Log readings during CAL – When checked, indicates that each calibration point during a calibration of a compatible OmniCure UV Curing system will be logged into the Data Log.

Source

The **Source** frame lists the optical inputs being detected by the R2000 Radiometer. Internal indicates detection from the optical input port on the R2000 Radiometer. Other sources such as Ext. #1 and Ext. #2 are sources being detected from external radiometer devices that are connected.

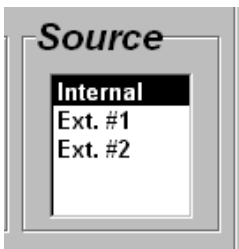

Menu Functions

To operate and control the R2000 Radiometer from the PC, select desired menu functions located across the top of the R2000 Control Panel.

Display

Select the Display menu and then select the desired mode of Power, Irradiance, Absolute or Relative.

Selected options are indicated as checked boxes in the **Display** frame.

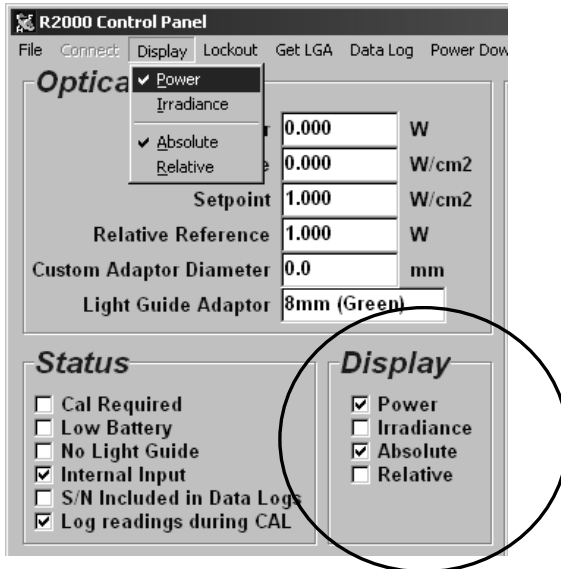

Lockout

Select Lockout menu option to disable certain features or functionality from the front keypad of the R2000 Radiometer.

Select from the available list in the pull-down menu. The selections that are checked are indicated in the **Lockout** frame.

If a box is checked, this means that this function will not operate from the front keypad of the R2000 Radiometer.

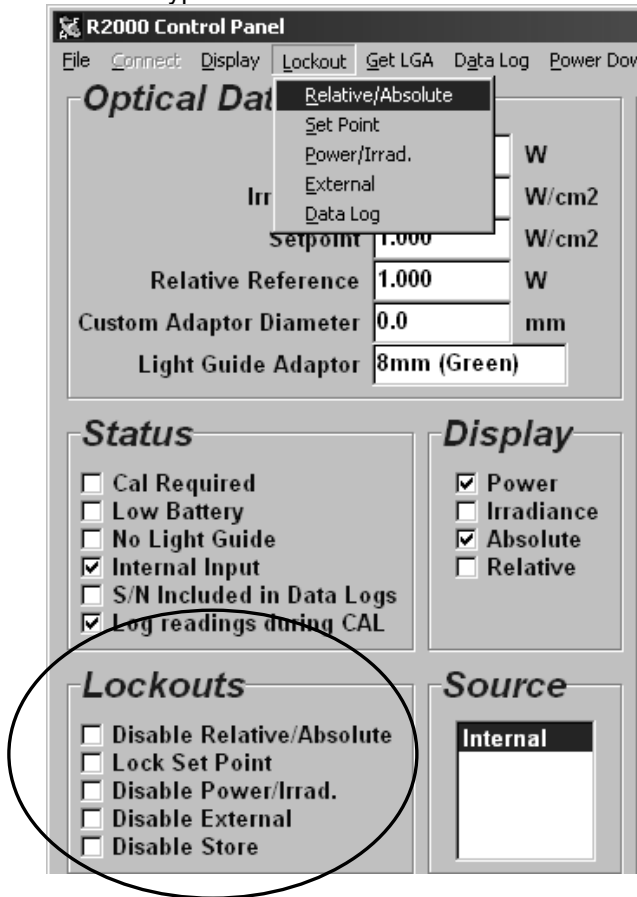

Get LGA

In the event that the size of the light guide adapter must be re-detected remotely, it can be obtained from the Get LGA menu option at the top of the screen. Selecting this will re-detect the colour of the light guide adapter and hence the size of the light guide installed in the R2000 Radiometer.

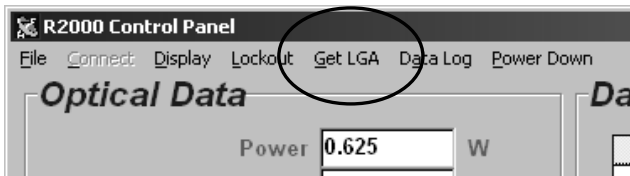

Data Log

Select the **Data Log** menu option and select the desired option from the pull down list.

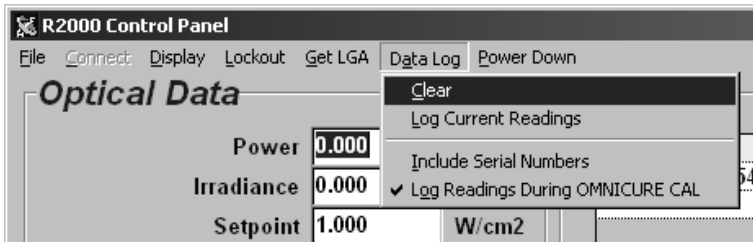

Select **C**lear to clear any existing data that may be resident in the data log.

Select **L**og Current Readings to **STORE** current readings from the R2000 Radiometer. The applicable data will be displayed in the Data Log frame.

Select **I**nclude Serial Numbers to obtain the serial number of the compatible OmniCure UV Curing System when the **STORE** button is pressed.

Select **L**og Readings During OMNISCURE CAL to log each calibration point into the Data Log during a calibration cycle with a compatible OmniCure UV Curing System.

The following is a sample screen shot of the Data Log,

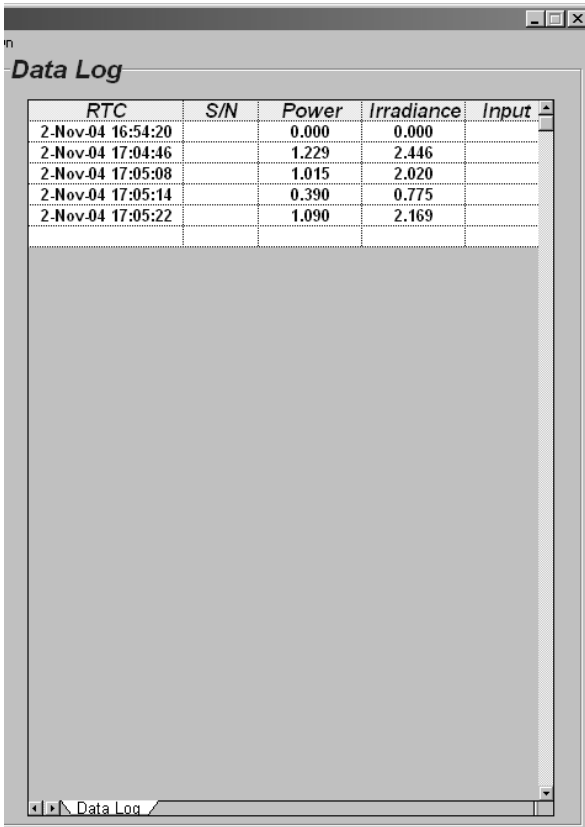

| RTC | S/N | Power | Irradiance | Input |
|-------------------|-----|-------|------------|-------|
| 2-Nov-04 16:54:20 | | 0.000 | 0.000 | |
| 2-Nov-04 17:04:46 | | 1.229 | 2.446 | |
| 2-Nov-04 17:05:08 | | 1.015 | 2.020 | |
| 2-Nov-04 17:05:14 | | 0.390 | 0.775 | |
| 2-Nov-04 17:05:22 | | 1.090 | 2.169 | |

Power Down

Select this menu option to power down the R2000 Radiometer.

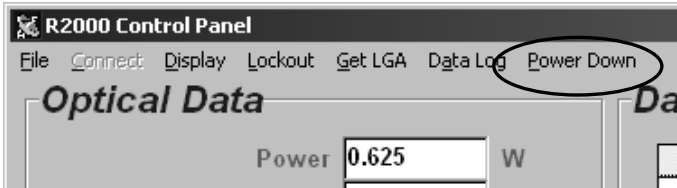

5 Glossary of Symbols and Safety Precautions



CAUTION – RISK OF DANGER

Consult accompanying documents



CAUTION!

Never look into the light emitting end of a light guide. The light could severely damage the cornea and retina of the eye if the light is observed directly. Eye shielding must be used at all times as well as protective clothing to protect exposed skin.



Battery



D.C. Current



Caution, hot surface

SAFETY PRECAUTIONS:



WARNING!

Should the R2000 Radiometer be used in a manner not specified by Excelitas Canada Inc. the protection provided by the equipment may be impaired.



WARNING!

The R2000 Radiometer is supplied with a lithium battery. Lithium batteries present a potential fire, explosion or severe burn hazard. **DO NOT** attempt to re-charge, disassemble, incinerate, short circuit or expose battery to temperatures above 100 degrees C or expose contents to water!



WARNING!

Used batteries are not to be discarded. Return to the nearest authorized Excelitas Canada Inc. service center for disposal/ re-cycling.

Lithium batteries must have terminals taped with non-conductive material prior to returning for disposal/ re-cycling to prevent short-circuiting. External packaging material must provide adequate protection to contents.

The lithium battery supplied in the R2000 Radiometer **DOES NOT** contain: mercury, lead, manganese or cadmium. Substitution of any other type of battery is not recommended and may void warranty.



Caution, hot surface

In instances where high power light sources are measured for extended periods of time, the light guide adaptors supplied with the R2000 may become hot! Always use caution when handling these adaptors!

6 Troubleshooting

Error Messages

6.1 *Display Indicates 'Adc' Message*

If an **Adc** message appear on the display it indicates that there is an internal problem with the unit during power up.

If this occurs, it is recommended that the R2000 Radiometer be serviced. See Section 9.



6.2 *Display Indicates 'BAT' Message*

If the **BAT** icon appears on the lower left side of the display it indicates that the battery is low and needs to be replaced. Refer to Section 8 for reordering information.



The battery is user replaceable.
Refer to Section 5 for warnings and safety precautions prior to replacing battery.

Remove the rubber boot if it is being used. Using a Philips screwdriver, open the battery compartment located on the back of the unit.

Remove the battery from its holder and replace with the same specified type observing correct polarity (+ and -). Substitution of any other type of battery is not recommended and will void the warranty. Refer to Section 8 for battery reorder information.

Close the battery compartment and hand-tighten into place. Place the R2000 Radiometer back into the rubber boot if desired.

Used batteries are not to be discarded. Return to the nearest authorized Excelitas Canada Inc. service center for disposal/ recycling. Use appropriate safety measures found in Section 5.

6.3 Display Indicates 'Cal' Message

If a **Cal** message appears on the display immediately following the R2000 Radiometer being turned ON, it indicates that the unit requires calibration. The message remains illuminated for 5 seconds.

If this occurs, it is recommended that the R2000 Radiometer be returned for calibration. See Section 8.



6.4 Display Indicates 'Err' Message

If an **Err** message appears on the display it indicates that a certain function was not completed successfully.

If the **SET** icon is displayed with the **Err** message it indicates that a SET function was not completed successfully.

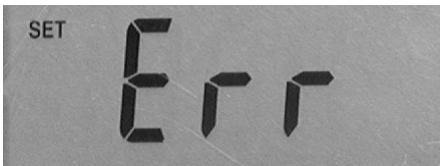

If the **EXT** icon is illuminated on the display with the **Err** message displayed it indicates that the R2000 Radiometer was unable to communicate with an external adapter.



6.5 Display Indicates 'LG' Message

The **LG** message as illustrated below will appear when the R2000 Radiometer is not detecting a light guide.

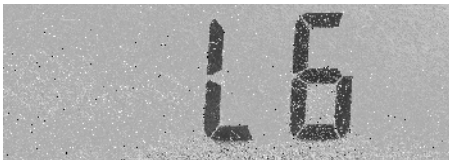

When a light guide is fully inserted the display will clear. If the message remains after the light guide has been inserted try removing the light guide and re-installing it.

6.6 Display Indicates 'LGA' Message

This message as illustrated below will appear when the R2000 Radiometer is unable to detect the colour of the light guide adapter. If this message appears it is recommended that the light guide adapter be cleaned or replaced.



6.7 Display Indicates 'Loc' Message

If the **Loc** message appears on the display when a keypad button is pressed it indicates that the function has been 'locked out'.



6.8 Display Indicates 'CLO' Message

If the "CLO" message appears on the display it indicates that there is something wrong with the Real-Time Clock (RTC). Most likely that the clock may not be set or has been reset. If this occurs it is recommended that the RTC be reset.

7 Technical Specifications*

7.1 Optical

Wavelength Range: 250-1000 nm

Maximum Range: Power: 1mW – 15W
Irradiance: 2mW/cm² – 475W/cm²

Resolution:

| | | |
|--------------|---------------|--------|
| Power Range: | 0.007-1.999mW | 0.01mW |
| | 2.00-19.99mW | 0.01mW |
| | 20-199.9mW | 0.1mW |
| | 200-1999mW | 1mW |
| | 2.00-19.99W | 10mW |

Accuracy: ± 5% typical,
± 10% maximum

Auto-ranging:

Power: 1 – 999 mW,
1 – 15W

Irradiance: 2mW/cm² – 999mW/cm²,
1 – 475 W/cm²

* Specifications are subject to change without notice.

7.2 Electrical

Battery Type: 3.6 volt Lithium, non-rechargeable
2.2 Ah

I/O Ports:

RS-232 Pin 1 (Shield) – GND
Pin 2 (Ring) – Tx
Pin 3 (Tip) – Rx

} Connect only to equipment that is IEC 950 compliant

Remote Input Port: 6-Pin Mini-DIN connector

(use only with optional Cure Site & Cure Ring radiometers)

7.3 Mechanical

Dimensions: 6.5 x 3.9 x 1.7 inches (L x W x H)
Without rubber boot

7.5 x 4.4 x 2 inches (L x W x H)
With rubber boot

Weight: 700 g
With rubber boot

7.4 RS-232 Communication Com Port Configuration:

Baud rate: 19200

Data bits: 8

Parity: None

Stop bits: 1

7.5 Environmental Conditions

Operating Environment Conditions

Installation Category II

Pollution Degree 2

Ambient Temperature: 10 to 35 degrees Celsius

Relative Humidity: 15% to 95% (non-condensing)

Atmospheric Pressure: 700 to 1060 hPa

Altitude: 2000 meters (maximum)

Transport and Storage Conditions

Temperature: -10 to 60 degrees Celsius

Relative Humidity: 10% to 100% (non-condensing)

Atmospheric Pressure: 500 to 1060 hPa

8 Regulatory Compliance

8.1 Safety and Electromagnetic Compatibility:

The R2000 Radiometer has been tested and found to comply with product safety and electromagnetic compatibility requirements. For a complete list of tests and for certification details, please contact your OmniCure representative or visit: <https://www.excelitas.com/product/omnicure-r2000-uv-radiometer>

CE Marking

| | | |
|--|-----------------------|---|
| Council Directive 2014/35/EU | Low Voltage Directive |  |
| Council Directive 2014/30/EU | EMC Directive | |
| Council Directive 2012/19/EU | WEEE Directive | |
| Council Directive 2011/65/EU as amended by (EU) 2015/863 | RoHS | |

This is a class A product. In a domestic environment, this product may cause radio interference in which case the user may be required to take adequate measures.

Information to User

FCC Class A Digital Device or Periphera;l

Note:

This equipment has been tested and found to comply with the limits for a Class A digital device, pursuant to Part 15 of the FCC Rules. These limits are designed to provide reasonable protection against harmful interference when the equipment is operated in a commercial environment. This equipment

generates, uses, and can radiate radio frequency energy and, if not installed and used in accordance with the instruction manual, may cause harmful interference to radio communications. Operation of this equipment in a residential area is likely to cause harmful interference in which case the user will be required to correct the interference at their own expense.

WARNING

Changes or modifications not expressly approved by Excelitas Technologies could void the user's authority to operate the equipment.

8.2 China RoHS



The symbol above indicates that this product is in compliance with China RoHS requirements.

| Part Name | Hazardous Substances | | | | | |
|----------------------------------|----------------------|--------------|--------------|-------------------------------|--------------------------------|---------------------------------------|
| | Lead (Pb) | Mercury (Hg) | Cadmium (Cd) | Hexavalent Chromium (Cr (VI)) | Polybrominated biphenyls (PBB) | Polybrominated diphenyl ethers (PBDE) |
| Printed circuit board assemblies | X | O | O | O | O | O |

This table is compiled according to SJ/T 11364.

O : Indicates that the content of the hazardous substance in all homogeneous materials of the part is below the limit requirement of GB/T 26572.

X : Indicates that the content of the hazardous substance in at least one of the homogeneous materials of the part exceeds the limit requirement specified by GB/T 26572.

8.3 WEEE Directive



The symbol above indicates that this product should not be disposed of along with municipal waste, that the product should be collected separately, and that a separate collection system exists for all products that contain this symbol within member states of the European Union.

The equipment that you bought has required the extraction and use of natural resources for its production. It may contain hazardous substances that could impact health and the environment.

In order to avoid the dissemination of those substances in our environment and to diminish the pressure on the natural resources, we encourage you to use the appropriate take-back systems. Those systems will reuse or recycle most of the materials of your end life equipment in a sound way.

The crossed-out wheeled bin symbol indicated above invites you to use those systems.

If you need more information on the collection, reuse and recycling systems, please contact your local or regional waste administration.

9 Accessories

Excelitas Canada Inc. carries a full line of replacement parts, supplies and accessories for the R2000 Radiometer.

Our team of light-based technology experts can recommend light delivery solutions for a range of manufacturing, illumination and biomedical applications. We also welcome custom requests for unique light delivery requirements.

3.6V Lithium Battery, Non-rechargeable

Reorder No. 020-00510

Light Guide Adapters

(Thumbscrew supplied)

2 mm - Gold

Reorder No. 019-01043

3mm – Red

Reorder No. 019-01050

5mm – Blue

Reorder No. 019-01051

8 mm – Green

Reorder No. 019-01042

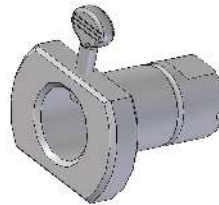

Optional Adapters

Optical accessories provide solutions to a wide range of situations. Optical accessories include the Proximity Measurement Adapter and the optional Lamp Output Adapter.

These adapters expand the range of measurement geometries that can be accommodated.

5mm Proximity Adapter
Reorder No. 019-01041

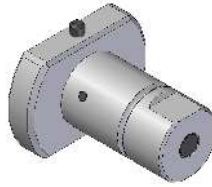

Lamp Output Adapter - Optional
Reorder No. 019-01033

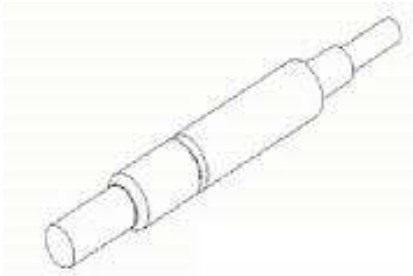

10 Warranty

Excelitas Technologies warrants, to the original purchaser for a period of one (1) full year, calculated from the date of purchase, that the equipment sold is free from defects in material and workmanship.

In the event of a claim under this guarantee, the equipment is to be sent postage and carriage paid, including a description of the fault, to the Excelitas Technologies Service Centre. Returned equipment will not be received without a Return Authorization (RA) Number, issued by the appropriate Service Centre. Alternatively you can fill out a request for Return Authorization (RA#) on our website

https://www.excelitas.com/ox_service_request_form.

Any claims for units received with defects in material or workmanship must be reported to an <https://www.excelitas.com/dealer-search> within 30 days from the original date of receipt. Excelitas Canada Inc. will repair or replace these reported defects free of charge for a period of up to 2 years from the original date of receipt. The equipment must be sent postage and carriage paid.

In order for us to serve you better, include a written description of the fault and the name and telephone number of a contact person who may be contacted for additional service related questions.

Package the R2000 Radiometer in its original shipping case or as appropriate to prevent damage during transport.

In the case of damage caused by wear and tear, careless handling, neglect, by the use of force or in the case of interventions and repairs not carried out by an Excelitas Technologies Service Centre, the guarantee ceases to be valid.

This guarantee may not form the basis for any claims for damages, in particular not for compensation of consequential damages.

Warning

There are no User serviceable parts within the R2000 Radiometer. Opening the main R2000 Radiometer enclosure will void the warranty.

11 Contact Information

Excelitas Canada Inc.
2260 Argentia Road
Mississauga, Ontario
L5N 6H7 CANADA

Tel.: +1 905 821-2600

Toll: +1 800 668-8752 (USA and Canada)

Fax: +1 905 821-2055

<https://www.excelitas.com/omnicure-x-cite-inquiries>

Technical Assistance:

techsupport@excelitas.com

https://www.excelitas.com/ox_service_request_form

For a complete listing of Authorized OmniCure Distributors and Service Centres, please go to

<https://www.excelitas.com/dealer-search>

<http://www.excelitas.com/omnicure>

Excelitas Canada Inc. 2022

All rights reserved

Page 52