

CERMAX<sup>®</sup>

# Cermax<sup>®</sup> Xenon Lamp Engineering Guide

This document may not be copied wholly or in part without prior written permission from Excelitas Technologies Corp. Excelitas Technologies will not bear the responsibility for negative effects incurred as a result of the operation of this equipment, irrespective of the contents of this document.

The contents of this document are subject to change without prior notification. Great care has been taken in the preparation of this document. However, if you should discover an error or an omission, please bring it to our attention. Cermax® is a registered trademark of Excelitas Technologies Corp. Other brand or product names are trademarks or registered trademarks of their respective holders.

**Excelitas Technologies Corp.**

6701 Koll Center Parkway, Suite 400  
Pleasanton, CA 94566  
United States  
Telephone: +1 510 979 6500  
Toll-free: +1 800 775 6786

[www.excelitas.com](http://www.excelitas.com)

NOTE: This Engineering Guide is intended as a tutorial regarding the design and performance characteristics of Cermax® Xenon lamps. As such, model numbers referenced in this Engineering Guide do not match the current nomenclature of the Cermax Xenon range under Excelitas Technologies Corp. Please visit [www.excelitas.com](http://www.excelitas.com) for more information on Excelitas' broad range of Cermax product offerings.

Copyright 2011, Excelitas Technologies Corp. All rights reserved.

Printed in U.S.A.

## Table of Contents

List of Figures .....	iv	4.2.1 Trigger .....	23
1.0 Introduction .....	1	4.2.2 Boost .....	25
1.1 Cermax Lamps .....	1	4.2.3 Transition to DC operation .....	27
1.2 Major Lamp Characteristics .....	1	4.3 Lamp Modulation, Pulsing, and Flashing .....	27
1.3 About This Guide .....	2	4.3.1 Modulation .....	27
2.0 Lamp Construction .....	2	4.3.2 Pulsing .....	29
2.1 Cermax Lamp Types .....	2	4.3.3 Circuits for pulsing .....	29
2.2 Lamp Construction .....	4	4.3.4 Cold flashing .....	30
2.3 Mechanical Dimensions and Tolerances .....	6	4.4 Lamp Power Supplies and Igniters .....	30
3.0 Optical Characteristics .....	6	4.5 Electromagnetic Interference (EMI) .....	31
3.1 Spectrum, Color, and Efficacy .....	6	5.0 Lamp Operation and Hazards .....	32
3.1.1 Spectrum .....	6	5.1 Lamp Cooling .....	32
3.1.2 Color .....	8	5.2 Electrical and Mechanical Connections .....	33
3.1.3 Efficacy .....	10	5.3 Lamp Safety .....	33
3.2 Arc Luminance .....	11	5.3.1 Explosion hazard .....	33
3.3 Illuminance .....	13	5.3.2 High-voltage hazard .....	34
3.3.1 Elliptical lamps .....	13	5.3.3 Ozone .....	34
3.3.2 Parabolic lamps .....	16	5.3.4 High light levels .....	34
3.4 Luminous Intensity .....	19	5.3.5 Thermal hazards .....	34
3.5 Scaling Laws .....	19	5.3.6 Lamp disposal .....	34
3.5.1 Output versus input current .....	19	6.0 Lamp Lifetime .....	35
3.5.2 Radiometric vs. photometric quantities .....	20	6.1 Other Factors Affecting Cermax Lamp Lifetime .....	35
3.5.3 Spectral quantities .....	20	7.0 Applications .....	36
3.6 Other Optical Characteristics .....	20	7.1 Fiberoptic Illumination .....	36
3.6.1 Output variation with time .....	20	7.2 Video Projection .....	38
3.6.2 Turn-on characteristics .....	21	7.3 UV Applications .....	39
4.0 Electrical Characteristics .....	21	7.4 Other Applications .....	40
4.1 V-I Curves .....	22	References .....	41
4.2 Lamp Ignition .....	23	Acknowledgments .....	41

## List of Figures

Figure 1: Typical Cermax lamp and quartz xenon short-arc lamp .....	1	Figure 23: Spot illuminance as a function of lamp age and aperture size for an EX500-13F lamp at 500 watts.....	17
Figure 2: Typical Cermax lamps .....	3	Figure 24: Lumen output versus aperture size for parabolic Cermax lamps with typical lenses .....	17
Figure 3: Pictorial view and cross section of a low-wattage Cermax lamp .....	4	Figure 25: Typical pinhole scan of the focal spot of an LX500CF lamp with an f/1 lens .....	18
Figure 4: Cermax lamp subassemblies being removed from brazing fixtures .....	4	Figure 26: Graph for estimating the focused output of 1-inch parabolic Cermax lamps .....	18
Figure 7: Fill pressures for standard Cermax lamp.....	5	Figure 27: Typical farfield beam shapes of LX300F and LX1000CF Cermax lamps .....	19
Figure 8: Reflector geometry and lamp body dimensions for a typical Cermax lamp (LX300F) .....	6	Figure 28: Output of EX300-10F lamp as a function of time after ignition.....	21
Figure 9: Cooling ring dimensions for 1-inch and 1-3/8-inch window Cermax lamps.....	7	Figure 29: A verage V-I curve for the LX300F lamp .....	22
Figure 10: Cermax lamp spectrum.....	9	Figure 30: Individual V-I curves for the EX300-10F lamp after 2 hours.....	22
Figure 11: Typical Cermax spectrum in the infrared .....	10	Figure 31: Individual V-I curves for the EX900-10F lamp after 2 hours.....	23
Figure 12: (a)1931 CIE chromaticity diagram. (b) Chromaticity diagram showing iso-temperature lines....	10	Figure 32: Typical Cermax lamp trigger pulse .....	24
Figure 13: Iso-brightness contours of an LX300F lamp as a function of lamp age.....	11	Figure 33: Typical lamp ignition circuit.....	24
Figure 14: Iso-brightness contours of an LX1000CF lamp ... ..	13	Figure 34: Typical voltage and current waveforms during ignition of Cermax lamps.....	25-26
Figure 15: Calibrated iso-brightness plot .....	13	Figure 35: Typical Cermax lamp V-I and impedance curves for pulsing (LX300F).....	28
Figure 16: Relative arc brightness of the cathode hotspot as a function of lamp age for an LX300F lamp .....	13	Figure 36: Typical complete Cermax lamp power supply (PS175SW-1).....	31
Figure 17: Lumen output versus aperture size for low-power elliptical Cermax lamps.....	14	Figure 37: Typical measured temperatures on 300-watt Cermax lamps.....	33
Figure 18: Continuation of Figure 17 to smaller aperture sizes .....	14	Figure 38: Lifetime curves for standard Cermax lamps run at reduced current .....	35
Figure 19: Lumen output versus aperture size for high-power elliptical Cermax lamps.....	15	Figure 40: Typical Cermax fiberoptic illumination systems.....	36
Figure 20: Typical output distributions of lamps at 2 hours and 24 hours .....	15	Figure 41: Typical lightguide numerical apertures and transmissions .....	36
Figure 21: Typical elliptical Cermax beam shape compared to Gaussian distribution.....	16	Figure 42: Typical Cermax video projector lightsource ..	38
Figure 22: EX300-10F spot diameter as a function of z-axis position and lamp age.....	17		

# Cermax® Xenon Lamp Engineering Guide

## 1.0 Introduction

### 1.1 Cermax® Xenon Lamps

Cermax high-intensity arc lamps are rugged and compact xenon short-arc lamps with fixed internal reflectors. They are based on patented technology and the name “Cermax” is a registered trademark of Excelitas Technologies.

Their primary distinguishing characteristics are focused output, extremely high brightness, and safe operation. Cermax Xenon lamps also provide broadband and stable output spectra. Their high brightness makes them ideal for applications such as fiberoptic illumination, video projection systems, and analytical instruments. Except for some specialized low-wattage, high-pressure mercury lamps, Cermax Xenon lamps provide greater brightness levels than any other commercially available incoherent light source and in some cases replace lasers. The mechanical integrity of Cermax lamps far exceeds that of any other type of short-arc lamp.

The purpose of this guide is to provide the system designer with the information needed to efficiently incorporate Cermax lamps into optical systems and achieve maximum performance. This guide describes the lamp construction details; the mechanical, optical, and electrical characteristics; operation details, including operating hazards and lamp lifetime; and specific applications.

### 1.2 Major Lamp Characteristics

Cermax lamps are similar in many ways to quartz xenon short-arc lamps, though they appear quite different (see Figure 1). The two types of lamps share spectral characteristics and often run from the same power supplies. Similarities also include stable color characteristics, excellent color rendition, instant-on with no color shift, and modulation capability. The fundamental efficacies of Cermax and quartz xenon lamps are close, about 20–30 lumens per watt below 1000 watts. This compares to about 70–100 lumens per watt for typical metal halide lamps. However, Cermax and quartz xenon lamps are rarely used in situations where raw luminous flux is the only important characteristic. Because Cermax and quartz xenon lamps have small arc gaps and high arc brightness, their light can be focused more easily onto small targets. In the case of Cermax lamps, the reflector collects more of the light than the typical metal halide lamp reflector. Consequently, in many applications Cermax lamps focus more light on the target than similar wattage metal halide lamps.



Figure 1: Typical Cermax lamp (left) and quartz xenon short-arc lamp (right). (Photos not to scale.)

Cermax® and quartz xenon lamps run from DC power supplies that are usually low-voltage (12—20 volts), high current power supplies with trigger and boost circuits for lamp ignition. Lifetimes for Cermax and quartz xenon lamps usually range from a minimum of 500 hours to 5000 or 10,000 hours, depending on the application.

Although Cermax and quartz xenon lamps have many similarities, it's the differences that highlight the strengths of the Cermax lamp. Advantages of Cermax lamps over quartz xenon lamps include compactness, small arc size, ruggedness, no devitrification of the lamp bulb, and the pre-aligned internal reflector. Because of the ceramic construction, a Cermax lamp (including reflector and cooling fins) is typically a fraction of the size of a comparable quartz xenon system.

- A Cermax lamp's arc size is usually shorter and its current level higher than those of a quartz xenon lamp at the same power. This causes the greater brightness of Cermax lamps.
- The ceramic construction makes the Cermax lamp very rugged and safe for user replacement. The ceramic-to-metal seals used in Cermax lamps achieve much higher strengths and are more consistent than the seals in quartz xenon lamps. Cermax lamps are the safest xenon arc lamps available.
- The pre-aligned reflector eliminates the need for any field alignment of lamp to reflector. The sapphire window in a Cermax lamp allows for wide spectral output (UV to 5 microns), but by adding a filter coating (F type lamps), the UV can be kept inside the lamp.

### 1.3 About This Guide

The information in this guide is intended to cover the Cermax product family. Therefore, the data was chosen to represent typical performance characteristics. There are over 20 standard Cermax lamps and hundreds of non-standard lamps that may differ in one or two specification items. For each standard Cermax lamp, there is a product specification sheet. Those sheets, along with this guide, should allow a designer to predict system performance in most cases.

Occasionally, a reference is made to engineering notes. These contain more detailed test data and are available from Excelitas Technologies. Some of the data represented here is from those engineering notes. When the data source is not referenced, the data was generated in our test labs and is not available in published form.

The information presented here is aimed at the system designer. In addition, there is a paper by Rovinskiy<sup>1</sup> that is an appropriate introduction to how xenon short-arc lamps are designed and how the design parameters affect performance. There are also other published papers that address the details of performance and electrode phenomena and may be helpful to system designers.<sup>2,3,4,5</sup>

To fully optimize the illumination system that uses a Cermax lamp, raytracing with optical design software programs is often required. Standard lens design programs, such as Beam 4<sup>6</sup>, Oslo<sup>7</sup>, and so on, are useful for rudimentary raytracing in optical systems that contain Cermax lamps. Nevertheless, to fully optimize the system, optical software programs (such as Solstis<sup>8</sup>) are required that can model the arc in the lamp and launch rays from many different points in the arc at many different angles. Engineering Note 227 provides a numerical arc map of a 300-watt Cermax lamp. Engineering Note 228 provides lens design parameters for some common commercially available aspheric condenser lenses.

A recommended general reference on photometric and radiometric testing and lamps in general is the IES Lighting Handbook.<sup>9</sup> A good reference on color is ColorScience<sup>10</sup> by Wyszecki and Stiles. Optical reflectors are covered in The Optical Design of Reflectors,<sup>11</sup> by Elmer.

## 2.0 Lamp Construction

### 2.1 Cermax Lamp Types

Figure 2 shows typical Cermax lamps. The various lamp models are most easily sorted by power level, reflector type, and spectral output.

The first distinguishing characteristic is power level. The standard power levels are 125, 175, 300, 500, and 1000 watts. Each of these power levels is actually a power range, with the nominal power level near the maximum.

For instance, a 300-watt Cermax Xenon lamp will normally operate from 180 to 320 watts, a 175-watt from 150 to 200 watts, and so on. The upper level of the power range is determined by the maximum temperature that the lamp can sustain and still meet its lifetime requirement. The minimum power level is determined by the requirement for long-term arc stability. The lamp will not be damaged if it is operated at very low powers for short periods of time. However, for example, operating a 300-watt

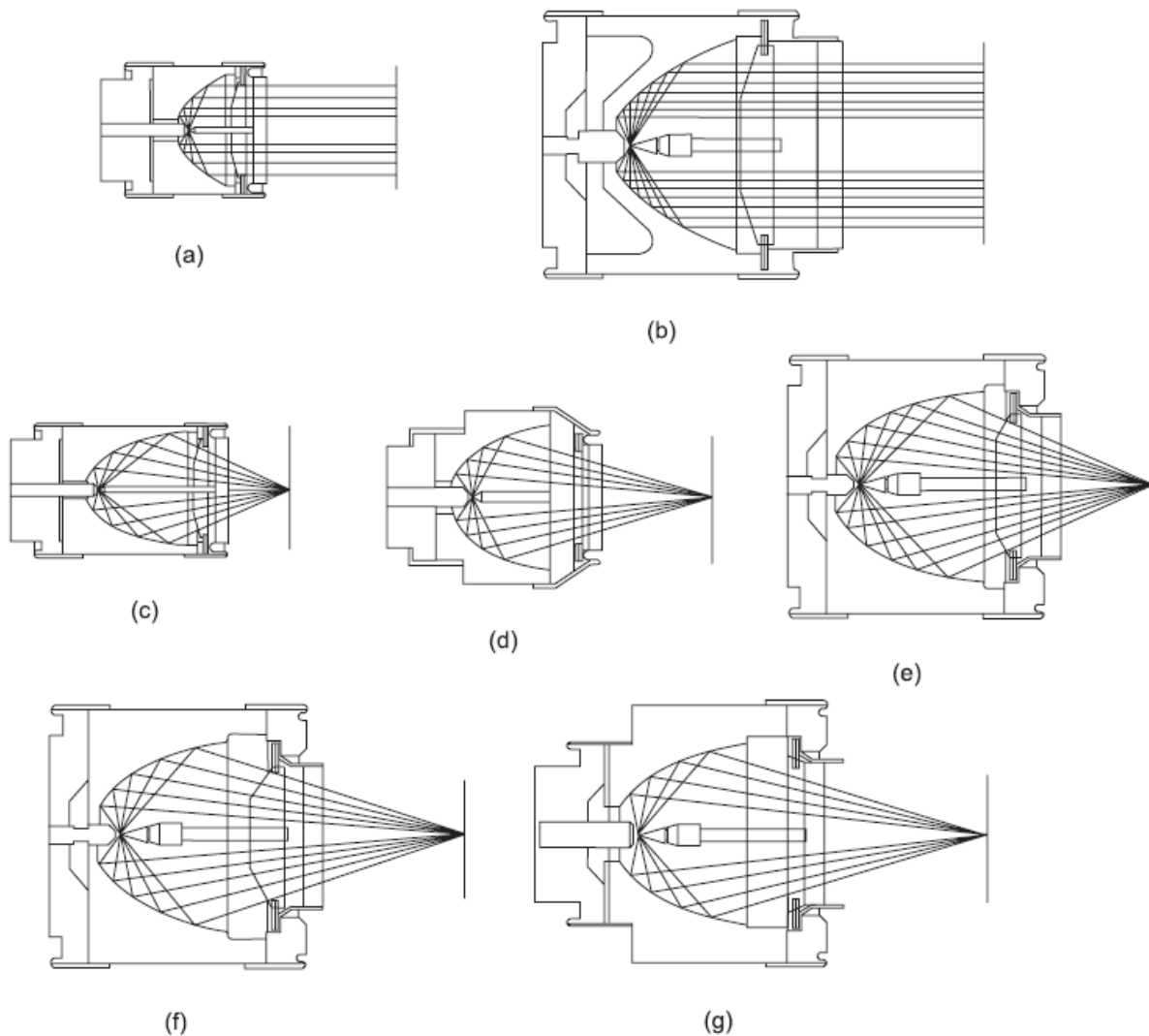

Figure 2: Typical Cermax lamps. (a) LX300F, (b) LX1000CF, (c) EX300-10F, (d) EX500-13F, (e) EX900C-10F, (f) EX900C-13F, (g) EX1000C-13F. (Rays are for illustration purposes and are not true raytraces.)

Lamp at become unstable and the light output to flicker in intensity. Check the individual product data sheets for power range and other specifications. The second characteristic is reflector type. For most power levels, both elliptical and parabolic Cermax® Xenon lamps are available. The elliptical lamps produce focused outputs and have slightly better collection efficiencies and slightly shorter arc gaps. The parabolic lamps produce collimated output beams and are usually used with focusing lenses. If an elliptical lamp is selected, the next choice is reflector “f-number.” Elliptical lamps up to the 300-

watt power level have f numbers of 1, 1.5, and 2. Excelitas Technologies defines f-number as the on-axis length from the end of the reflector to the focal point, divided by twice the radial height of the highest marginal ray as it strikes the reflector. The 500- and 1000-watt elliptical lamps have f numbers of 1 and 1.3, respectively. It is important to distinguish between the theoretical f number and the effective f-number. Because very few optical rays are reflected from the outermost edge of the reflector in Cermax Xenon lamps, the theoretical lamp f-number that best matches a particular optical

system may not be the same as the system f-number. For example, an f/1.3 Cermax lamp may be the best match for an f/1.5 optical system. The third characteristic is spectral output. Cermax® lamps are optimized for either ultraviolet (UV) emission or for visible use. The visible lamps have a filter coating on the lamp window to absorb and reflect unwanted UV back into the lamp. Therefore, Cermax lamps optimized for the visible have an F suffix, for filtered, in their model numbers, while the model numbers of UV-emitting lamps contain the letters UV.

The model numbers for Cermax lamps contain information about the power and construction choices. Standard Cermax lamps have model numbers such as LX300F or EX500-13UV. LX signifies a collimated output and parabolic-shaped reflector lamp; EX signifies a focused output and an elliptical-shaped reflector lamp. The next three or four digits give the nominal power (e.g. 300 watts or 500 watts). In the case of elliptical lamps, the -13 (or -10, -15, -20, etc.) represents the nominal f-number. For example, -13 signifies f/1.3. There are custom Cermax lamps for original equipment manufacturers whose model numbers begin with Y, such as Y1052. These numbers are assigned sequentially and do not contain information about construction. Such OEM lamps usually feature some characteristic, specification, or test parameter which differs from those of standard lamps. These Y-lamps are not generally available to customers other than those for whom the lamps were designed. It is very risky to relamp a fixture or lightsource with a Cermax lamp that does not have the exact model number of the original lamp. Cermax lamps that appear identical can have vastly different performance characteristics.

## 2.2 Lamp Construction

Figure 3 shows a pictorial view and a cross section of a low-wattage parabolic Cermax lamp. Most Cermax Xenon lamps are similar in construction, although individual parts may vary slightly. The lamp is constructed entirely of metal and ceramic. No organic (carbon-based) materials, mercury, rare-earth elements, or any other materials with disposal problems are used in the lamp construction. The fill gas, xenon, is inert and nontoxic. The lamp subassemblies are constructed with high-temperature brazes in fixtures that constrain the assemblies to tight dimensional tolerances. Figure 4

shows some of these lamps subassemblies and fixtures after brazing.

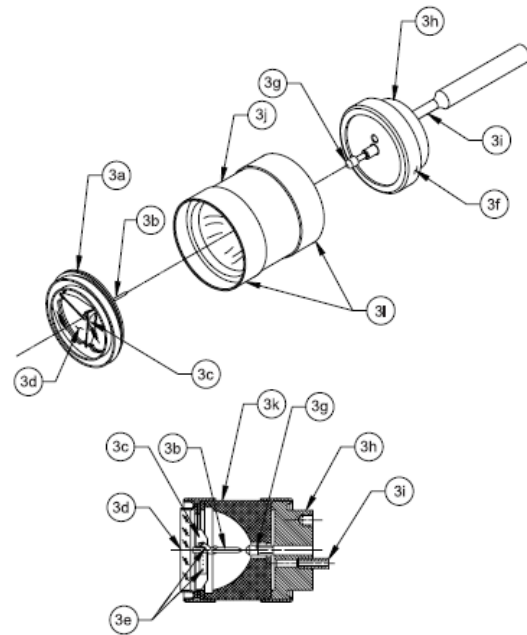

Figure 4: Cermax lamp subassemblies being removed from brazing fixtures

There are three main subassemblies in the Cermax lamp: cathode, anode, and reflector. The cathode assembly (3a) contains the lamp cathode (3b), the struts holding the cathode to the window flange (3c), the window (3d), and the getters (3e). The lamp cathode is a small, pencil-shaped part made from thoriated tungsten. During operation, the cathode emits electrons that migrate across the lamp arc gap and strike the anode. The electrons are emitted thermionically from the cathode, meaning the cathode tip must maintain a high temperature and low-electron-emission work function. The cathode struts (3c) hold the cathode rigidly in place and conduct current to the cathode. The lamp window (3d) is ground and polished single-crystal sapphire (AlO<sub>2</sub>). Sapphire is chosen to allow the thermal expansion of the window to match the flange thermal expansion so that a hermetic seal is maintained over a wide operating temperature range. Another advantage of sapphire is its good thermal conductivity, which transports heat to the flange of the lamp and distributes the heat evenly to avoid cracking the window. Getters (3e) are wrapped around the cathode and placed on the struts. Their function is to absorb contaminant gases that evolve



in the lamp during operation and to extend lamp life by preventing the contaminants from poisoning the cathode and transporting unwanted materials onto the reflector and window. The anode assembly (3f) is composed of the anode (3g), the base (3h), and tubulation (3i). The anode (3g) is constructed from pure tungsten and is much blunter in shape than the cathode. This shape is mostly the result of the discharge physics that causes the arc to spread at its positive electrical attachment point. The arc is actually somewhat conical in shape, with the point of the cone touching the cathode and the base of the cone resting on the anode. The anode is larger than the cathode, to conduct more heat. About 80% of the conducted waste heat in the lamp is conducted out through the anode, and 20% is conducted through the cathode. Therefore, the anode has been designed to have a lower thermal resistance path to the lamp heatsinks. This explains why the lamp base (3h) is relatively massive. The base is constructed of iron or other thermally conductive material to conduct heat loads from the lamp anode. The tubulation (3i) is the port for evacuating the lamp and filling it with xenon gas. After filling, the tubulation is pinched or cold-welded with a hydraulic tool and the lamp is simultaneously sealed and cut off from the filling and processing station. The reflector assembly (3j) consists of the reflector (3k) and two sleeves (3l). The reflector is a nearly pure polycrystalline alumina body that is glazed with a high temperature material to give the reflector a specular surface. Reflectors are batch-checked to ensure that the reflector figure will not degrade the lamp's optical performance (Figure 5). The reflector is then sealed to its sleeves (3l) and the reflective coating is applied to the glazed inner surface. For visible F lamps, the reflector is coated

with a silver alloy. For UV lamps, the reflector receives an aluminum coating. An advantage of the sealed reflector construction of Cermax® lamps, and of the inert xenon fill gas, is that the reflectors are quickly sealed into the final lamp assembly, eliminating the chance for oxidation to degrade the reflector's surface.

The three lamp assemblies are finally sealed by tungsten-inert-gas (TIG) welding the cathode and anode sleeves (3l). Before sealing, the assemblies are checked to ensure that the arc gap is correct and is positioned accurately relative to the reflector. The lamps are leak-checked, pressure tested to beyond operation pressure, and then evacuated and baked out on the pump and fill station to eliminate any remaining contaminants (Figure 6). Cold xenon fill pressures for standard Cermax lamps are listed in Figure 7. After filling, the lamps are burned in for at least 2 hours to stabilize the cathode. All lamps are then tested for light output, either in the specific equipment where they will be operated or in generic test setups. The lamps also receive a test for trigger ability and various dimensional and cosmetic checks.

Lamp Model Number	Cold Fill Pressure (psi)
LX125 (F + UV)	250
LX175 (F + UV)	250
LX300 (F + UV)	250
LX500C (F + UV)	280
LX1000C (F + UV)	280
EX125-10 (F + UV)	350
EX175-10 (F + UV)	350
EX300-10 (F + UV)	350
EX500-10 (F + UV)	305
EX500-13 (F + UV)	305
EX900C-10 (F + UV)	325
EX900C-13 (F + UV)	325
EX1000C-10 (F + UV)	325
EX1000C-13 (F + UV)	325

Figure 7: Fill pressures for standard Cermax lamps

### 2.3 Mechanical Dimensions and Tolerances

Figure 8 shows the reflector and lamp body dimensions for a typical Cermax® Xenon lamp. Drawings such as Figure 8 are provided in individual lamp product specification sheets. The tolerances are important in designing heatsinks and mating mechanical parts, because good mechanical fit to the heatsinks is essential for extracting the heat from the lamp and maintaining low lamp operating temperatures. Because the tubulation is the most fragile part of the lamp it should be carefully protected. A sharp blow to the tubulation may cause the cold weld seal to open, causing the gas to be vented and rendering the lamp useless. Such a failure is not explosive. In fact, squeezing the tabulation with a pair of pliers is the recommended way of relieving the internal pressure in worn-out lamps to render them totally harmless.

The only additional mechanical information needed to construct heatsinks for Cermax lamps are the dimensions of the window cooling rings that attach to the window. Figure 9 lists the cooling ring dimensions for the two window diameters in elliptical Cermax lamps. The user often needs to know how accurately the light output direction and spot location are controlled relative to the lamp body. For parabolic Cermax lamps, the center of the output beam is within  $-2$  degrees of the normal from the lamp base (i.e., the lamp surface that contains the tubulation). For elliptical EX300-10F Cermax lamps, the centers of the lamps focal spots lie within a circle 2 mm in diameter.

### 3.0 Optical Characteristics

#### 3.1 Spectrum, Color, and Efficacy

##### 3.1.1 Spectrum

One of the unique characteristics of Cermax lamps and of quartz xenon short-arc lamps in general is the remarkably stable spectrum. Figure 10 shows a Cermax spectrum in the UV, visible, and near IR. If the lamp has a coating to eliminate the UV, the 200- to 300-nm radiation will be missing from the lamp output. The radiation has several different components. The line radiation from 800–1000 nm is the result of bound-bound transitions in the xenon atoms and ions. The continuum is made up primarily of recombination radiation from gas ions capturing electrons into bound states (free-bound transitions) and from Bremsstrahlung radiation (free-free transitions). As the lamp power changes over very wide power ranges (very much wider than those recommended for normal operation), the relative intensity of the line-versus-continuum radiation also changes. At extremely low powers, the line radiation dominates. As the power is increased, the continuum radiation becomes more dominant, until at extremely high powers the continuum radiation will almost drown out the line radiation. Such an extreme case is seen in xenon flashlamps at the peak of the lamp pulse.<sup>12</sup>

However, the power densities seen in normal Cermax lamps cover a minute range compared to these extremes. All Cermax Xenon lamps have the same spectrum in their specified power ranges.

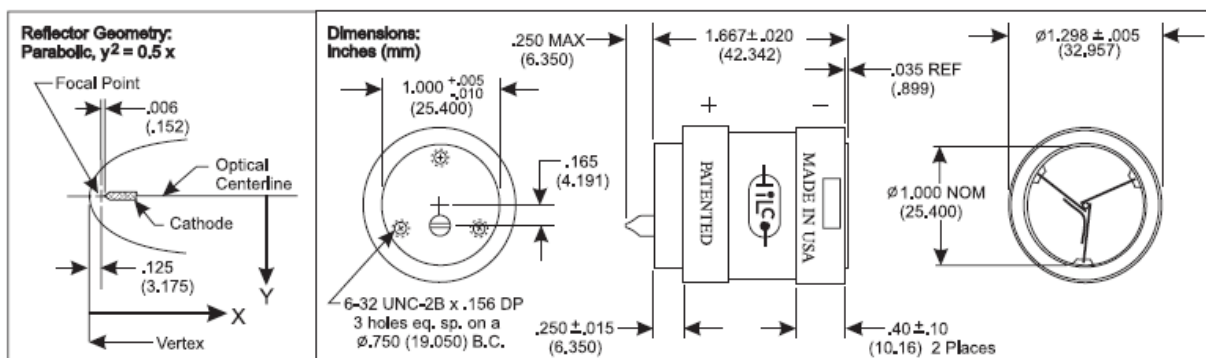

Figure 8: Reflector geometry and lamp body dimensions for a typical Cermax lamp (LX300F).

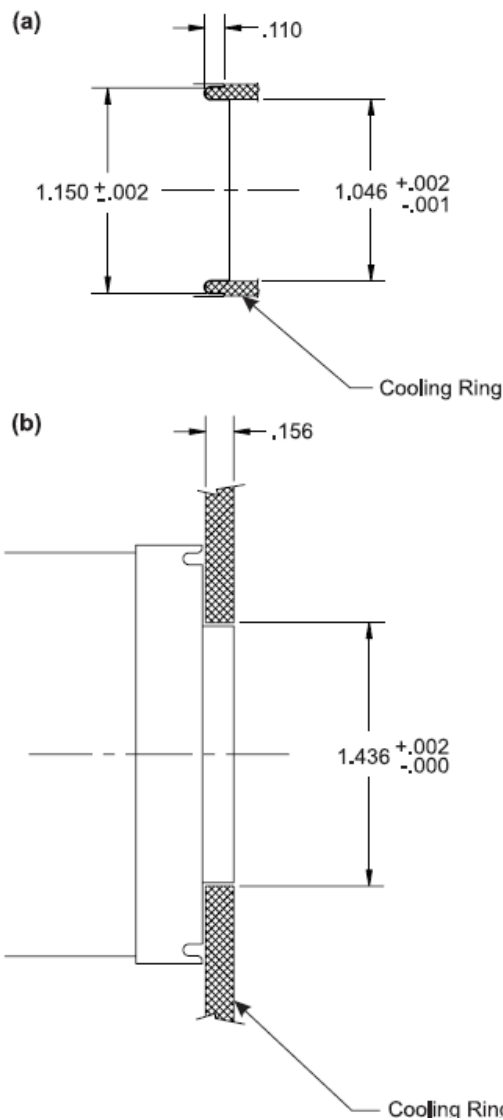

Figure 9: Cooling ring dimensions for 1-inch and 1-3/8-inch window Cermax lamps.

Another factor important in explaining the xenon spectrum is the plasma emissivity. Measurements have been made of the xenon plasma emissivity as a function of wavelength and peak current for flashlamps<sup>13</sup> and of the transparency of high-pressure xenon arcs.<sup>14</sup> In general, the emissivity of xenon plasmas in Cermax® lamps in the visible spectrum is less than 1. This means that the arc is partially transparent. The emissivity is higher in the infrared than in the visible and higher in the visible than in the UV. In the far infrared (1–5 microns,) the emissivity is close to 1. When the current is increased in a Cermax lamp, the arc expands slightly. The spectrum and the correlated color temperature

(CCT) of the arc should change because of the increased power density. In fact, the spectrum in the visible hardly changes at all, because the arc expansion, the emissivity, and the blackbody radiation changes tend to cancel each other out. The spectrum and CCT stay almost the same and the spectral intensity goes up uniformly.

The temperature of the gas in the arc column of a Cermax lamp is much higher than the measured 6000 K CCT. However, because of the lower plasma emissivity at shorter wavelengths, the shape of the spectrum in the visible is flat and is a good approximation of sunlight. The xenon plasma emissivity is useful in explaining why the spectrum behaves in certain ways. However, because of the large number of variables involved, it is almost impossible to calculate the spectrum, or even selected spectral power densities, from the emissivity and other plasma parameters.

In the far infrared, Cermax lamps behave like blackbodies with high emissivities. Figure 11 shows a typical Cermax spectrum in the 1–5 micron range. Cermax lamps are occasionally used as infrared sources because their output can be temporally modulated. However, some of the infrared radiation results from incandescent radiation from the hot electrodes in the Cermax lamp. Also, xenon has a significant afterglow. So in the case of modulation in the lamp, even after the current pulse has gone to zero or to a very low value, the plasma can radiate and provide an infrared tail.

One of the unique phenomena of xenon arc lamps, and of Cermax lamps in particular, is the existence of a cathode hot spot. Because of cathode emission processes, the arc is constricted at the cathode end of the arc gap and a hot spot appears in the gas detached from the cathode. The CCT of the gas is extremely high at the cathode spot, on the order of 20,000 K. The cathode hot spot in a Cermax lamp (see section 3.2) is at a higher CCT than the bulk of the arc. However, because of the extremely small size of the hot spot and because the Cermax reflector tends to blur the arc components, it is very difficult to make spectral measurements in the illuminated field of view of a Cermax lamp that shows different spectra.

### 3.1.2 Color

Figure 12 shows the 1931 CIE chromaticity diagram<sup>15</sup> that is usually used to describe the color characteristics of lamps. Other references explain the derivation and use of this diagram.<sup>10</sup> The curved line near the center of Figure 12a represents the locus of color coordinates and CCTs for pure blackbodies. The numbers along the curved line (3500, 4800, 6500, etc.) represent the color temperatures. Figure 12b represents a magnified image of the curved line.

Measurements of many Cermax® Xenon lamps indicate that the average CCT is about 6150 K when the lamps are only a few hours old. There is a

standard deviation of about 150K, indicating that the Cermax color temperature should never be specified closer than  $\pm 450$  K unless the application is extremely color-critical. (Near 6000 K, a variation of 150 degrees is almost an imperceptible color temperature difference. By contrast, a 150-degree color temperature difference near 3000 K would be noticeable.) As a Cermax lamp ages, the average CCT decreases by 200—250 K in the first 400 hours and by the same amount again in the next 600 hours.

The Color Rendering Index (CRI) for Cermax as well as quartz xenon lamps is 95 to 99. A CRI of 100 would mean the lamp's ability to accurately render colors was equivalent to that of daylight.

Figure 10: Cermax lamp spectrum. The typical spectral radiant flux for each lamp type is plotted versus wavelength. Output is the total light emitted from the lamp in all directions.

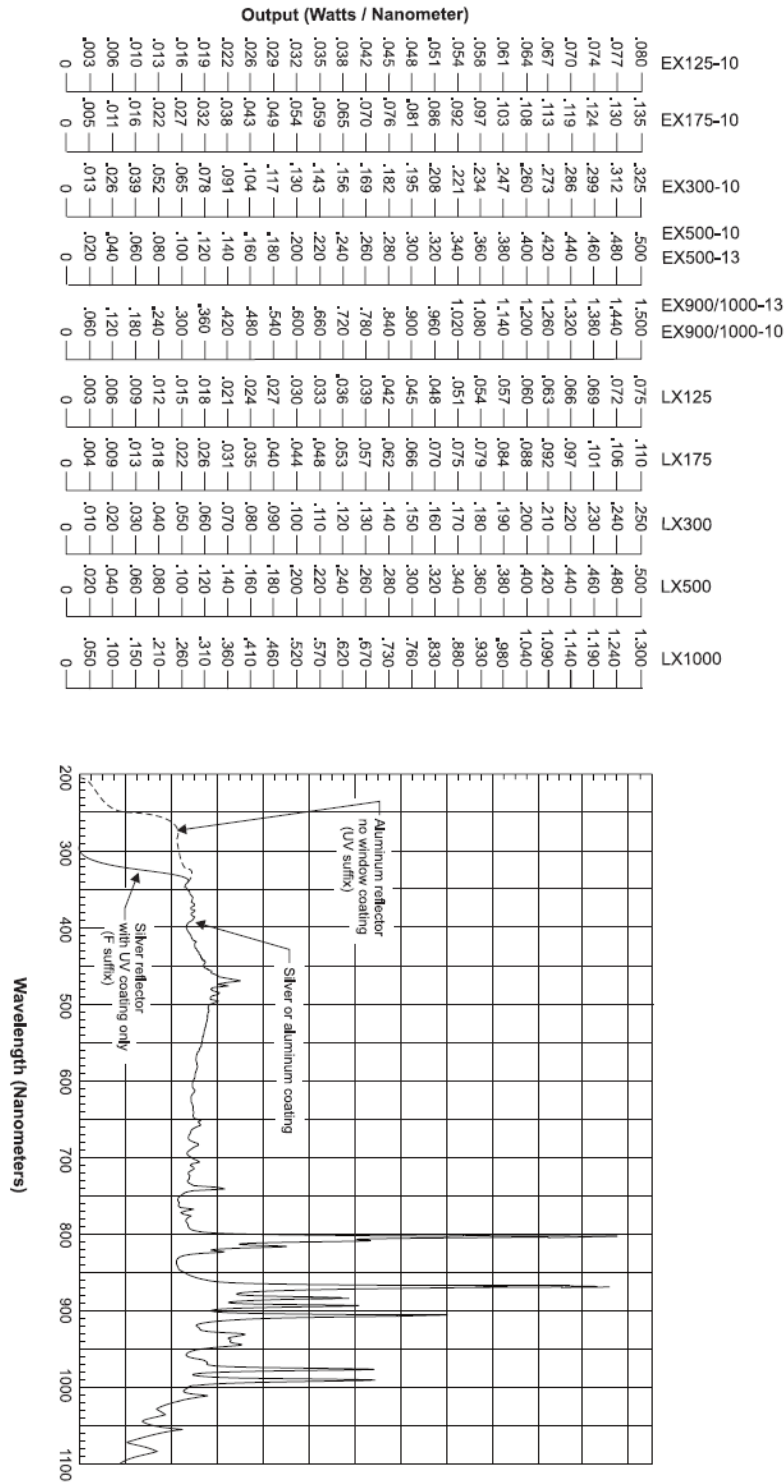

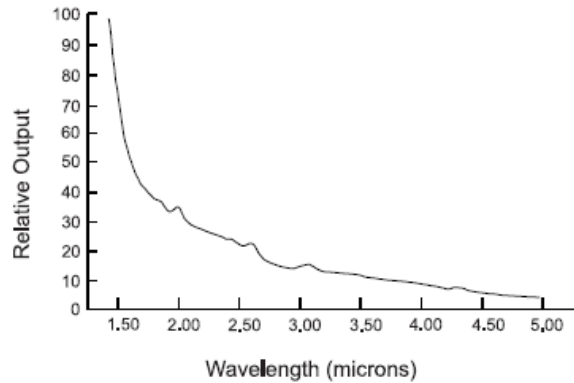

Figure 11: Typical Cermax spectrum in the infrared.

Figure 12: (a) 1931 CIE chromaticity diagram. (b) Chromaticity diagram showing iso-temperature lines. Lines of constant correlated color temperature are given at every 10 reciprocal megakelvins. Average Cermax coordinates are (0.320, 0.325)(6150 K).

The average xy color coordinates of Cermax® Xenon lamps are 0.320 and 0.325. The standard deviations of these coordinates are 0.0026. By plotting the x and y coordinates on Figure 12b, one can see how remarkably close a Cermax lamp color is to that of an ideal blackbody at 6150 K.

### 3.1.3 Efficacy

Efficacy is a term that describes a lamp's ability to produce efficient visible light. It is the total luminous flux emitted divided by the total lamp power input (lumens per watt).

Xenon gas is used in Cermax lamps because of its radiative efficiency. Going down the periodic table of noble gases, radiative efficiency increases as gas atomic weight increases. Xenon is the heaviest available noble gas because radon is highly radioactive. Lighter gases, such as argon or krypton, are occasionally used in lamps that can use the specific line radiation of these gases. However, because xenon is much more efficient than

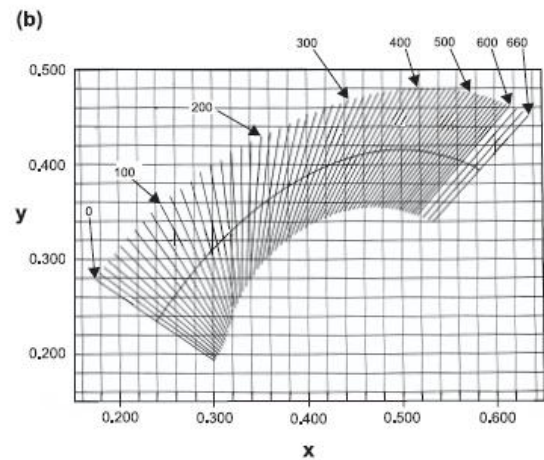
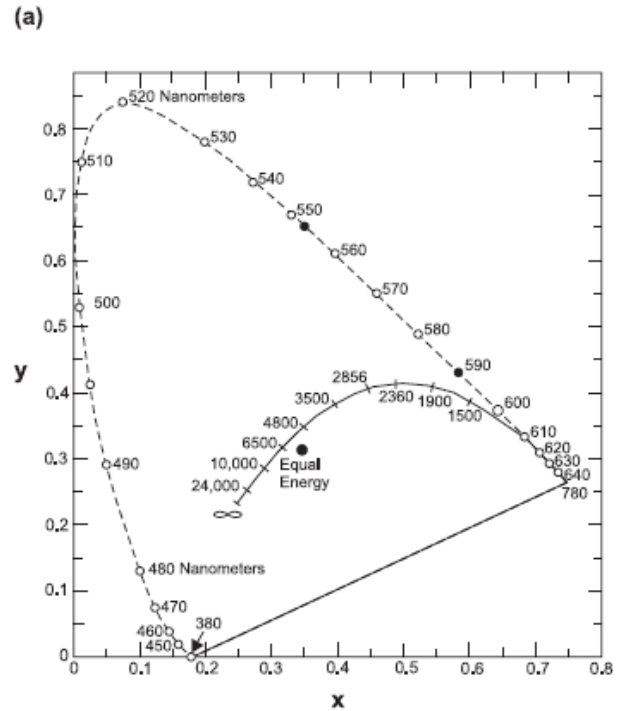

these lighter gases, non-xenon DC short-arc lamps are rare. As we have mentioned, the efficacy of xenon lamps in general and of Cermax® Xenon lamps in particular is in the range of 20–30 lumens per watt for lamps under 1000 watts. At higher powers, xenon short-arc lamps can sometimes achieve 50 lumens per watt. However, lumens per watt delivered on the target is the important measurement, and because of the internal reflector, it is difficult to compare Cermax lamps to other lamps based on raw efficacy. Often the number of lumens per watt delivered by a Cermax Xenon lamp is equal to or greater than that delivered by a reflectorized metal halide lamp.

Increasing the arc gap tends to increase lamp efficacy at the expense of illuminance. Increasing Cermox gas fill pressure also increases efficacy up to the maximum safe operating pressure.

### 3.2 Arc Luminance

Luminance is a measure of light flux emitted from a surface. Arc brightness is an older photometric term referring to arc luminance. Though brightness is a very descriptive term for emitted light per unit source area, it is scientifically ambiguous, because it can refer either to a physiological sensation or to a physically measured quantity. Luminance has units of candelas per square meter. A candela is a lumen per steradian.

Figures 13 and 14 show the measured iso-brightness contours for actual arcs in Cermox Xenon lamps. If the contours were calibrated in candelas per  $\text{mm}^2$ , Figures 13 and 14 would properly define the arc luminance completely. Such a typical calibrated iso-brightness plot is shown in Figure 15. With quartz xenon arc lamps, this would be the usual starting point for raytracing and the actual prediction of illumination system performance. However, as mentioned in section 3.1, the arc is partially transparent. If one raytraces with the iso-brightness contours as the starting point, the model will probably not distribute the emitting rays properly to account for the differences in emissivity. This is

particularly true of lamps and optical systems that contain high collection efficiency reflectors, such as Cermox lamps. The iso-brightness contours are useful in raytracing as long as it is understood that the model will probably have built-in errors.

The best theoretical system raytrace models are those in which the iso-brightness contours are used as a relative starting point for the rays. That is, the number of rays originating from a portion of the arc is scaled to the contour numbers on that portion of the iso brightness plot. When the raytrace program traces the rays through the focal point of the lamp or system, the number of rays should then be scaled with the measured spot illuminances (see section 3.3) to arrive at the proper prediction of system performance.

The arc iso-brightness plots also illustrate the effects of age, arc length, pressure, and convection on arc illuminance. The various iso-brightness plots in Figure 13 show the normal effects of lamp aging. The cathode hotspot tends to get larger and spread radially, resulting in decreasing illuminance. Not only does it decrease, but it decreases at a faster rate than the overall lamp illuminance (see section 3.3.1). Also, the cathode tip erodes into a rounder shape. Figure 16 shows the illuminance of the arc hot spots of the lamps in Figure 13 as a function of lamp age.

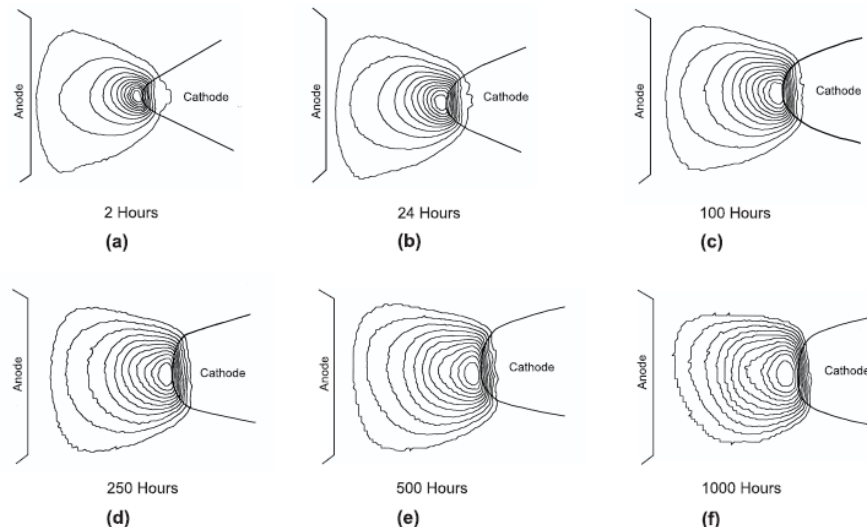

Figure 13: Iso-brightness contours of an LX300F lamp as a function of lamp age. Lamp current was 20 amps. Arc gap was 0.049 inches.

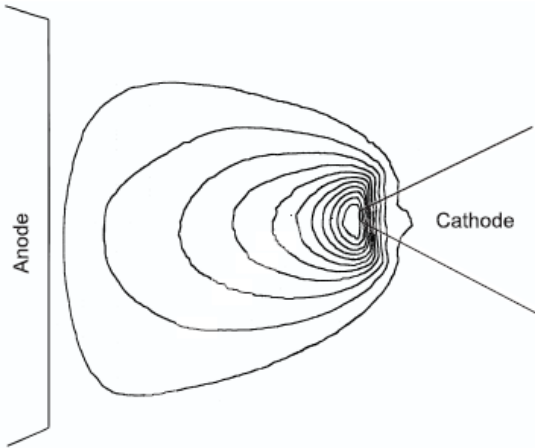

Figure 14: Iso-brightness contours of an LX1000CF lamp. Lamp current was 50 amps. Arc gap was 0.090 inches.

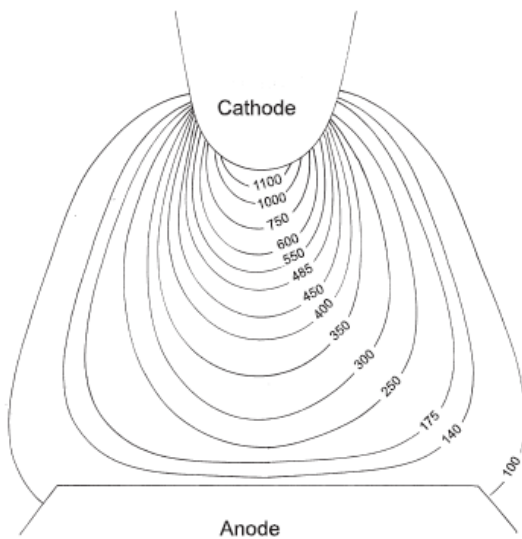

Figure 15: Calibrated iso-brightness plot. 300-watt lamp running at 250 watts, 4 hours old, 0.050-inch arc gap. Contours are in candelas/mm<sup>2</sup>.

Comparison of Figures 13 and 14 illustrates the effects of arc length on arc illuminance. Increasing the arc length tends to stretch out the contours of the main body of the arc. Increasing current tends to increase the illuminance, but also increases the arc diameter. Increasing the gas fill pressure tends to constrict the arc in diameter. However, the gas fill pressure is usually determined by the highest safe operating pressure that the lamp can sustain. Therefore, fill pressure is not an optional design variable.

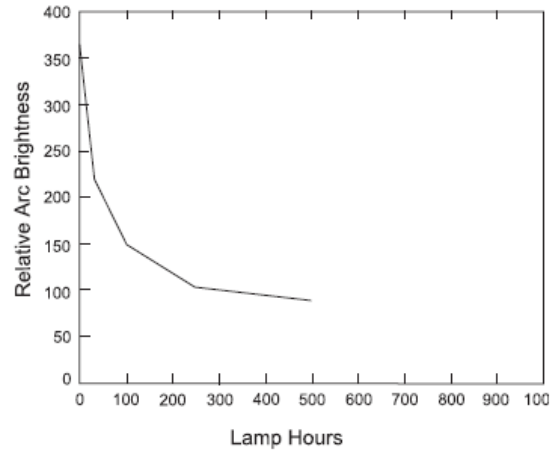

Figure 16: Relative arc brightness of the cathode hot spot as a function of lamp age for an LX300F lamp.

None of the variables age, arc length, or fill pressure qualitatively affects the appearance of the arc iso-brightness plots. Obviously, if the arc length were increased a great deal, the plots would take on a different appearance. Close examination of the plots in Figure 13 reveals that the arcs are not perfectly rotationally symmetric. Convection inside the lamp causes the asymmetry. This lightly upward-bowing arc is normally very small, because the relatively high current and short arc gap in Cermax<sup>®</sup> Xenon lamps limit this effect. At very low currents (lower than the recommended operating range), the bowing can become large, and is one factor in the increased lamp voltage at low currents because the effective arc length is increased.

### 3.3 Illuminance

With un-reflectorized lamps, the most important characteristic is the arc luminance, because light emitted from the arc in all directions is gathered by the user's system and redirected where desired. With reflectorized lamps such as Cermax lamps, the most important characteristic is illuminance, which is defined as the density of luminous flux incident on a surface. If the field of illumination of a lamp is evenly lit, the illuminance is usually expressed in foot-candles (lumens/square foot) or lux (lumens/square meter) at a certain distance. This is the case with reflectorized lamps used for general illumination such as fluorescent lamp fixtures. In the case of highly focused lamps, such as Cermax and other small elliptical reflector lamps, it is customary



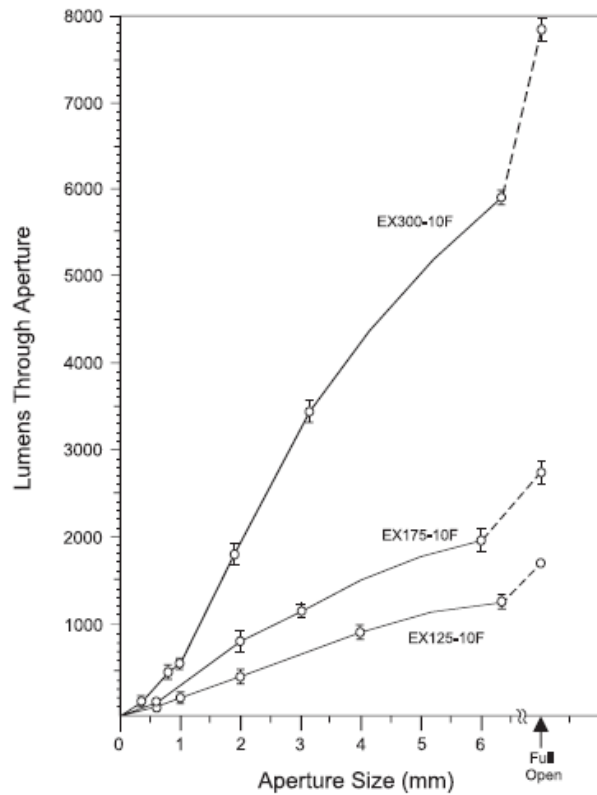

illuminance as the Figure 17: Lumen output versus aperture size for low-power elliptical Cermax lamps. "Full Open" indicates total output without an aperture. Measurements taken at nominal lamp power and 2-hour lamp age.

to express number of lumens captured by various-sized apertures. If the shape of the illuminated spot is also given, the system designer can calculate the light useful to the system.

The illuminance characteristics for both elliptical and parabolic reflector Cermax® Xenon lamps are discussed in the next two sections. In elliptical Cermax lamps, the obvious place to make the illuminance measurements is the reflector focal spot. In parabolic Cermax lamps, the data is taken with commonly used focusing lenses. Even with parabolic Cermax lamps, the vast majority of applications involve focusing the lamp output as soon as the light exits the lamp. In section 3.4 data is presented on parabolic Cermax lamps used without focusing systems.

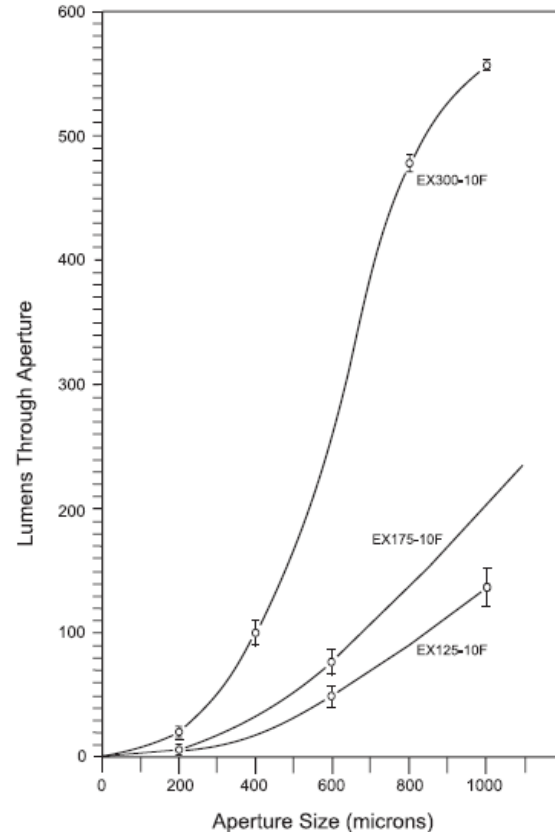

Figure 18: Continuation of Figure 17 to smaller aperture sizes.

### 3.3.1 Elliptical lamps

Figure 17 shows the lumen output versus aperture size for a number of low-power elliptical Cermax lamps.<sup>16, 17, 18</sup> Various-sized circular apertures were inserted at the focal spots of lamps, and the light that was transmitted through the apertures was gathered in an integrating sphere. The aperture positions were optimized in all orthogonal directions to maximize the lumen readings. The power densities even in low-power Cermax lamps are high enough that the apertures need to be heatsunk or watercooled. Figure 18 is a continuation of the data for small aperture sizes. Figure 19 shows the comparable data for higher-power Cermax lamps<sup>19, 20</sup> (Error bars represent standard deviation of the 2- to 4-lamp test sample.)

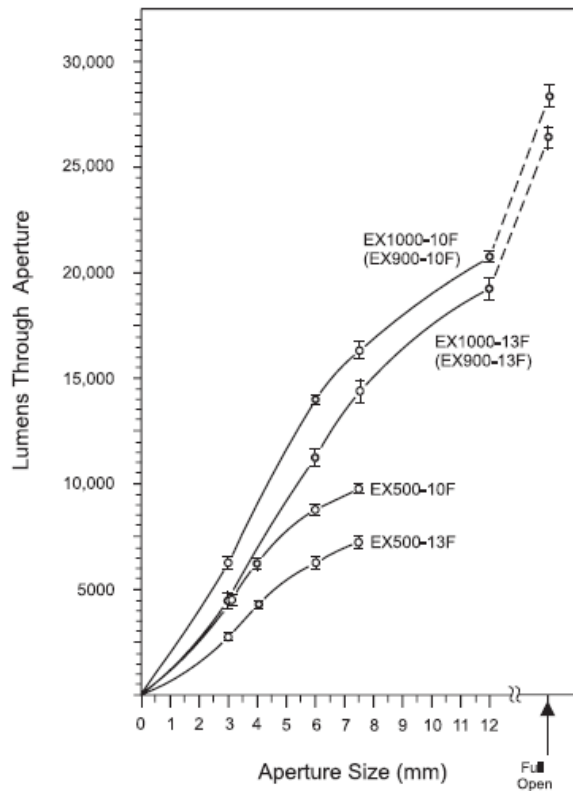

Figure 19: Lumen output versus aperture size for high-power elliptical Cermax lamps. "Full Open" indicates total output without an aperture.

Measurements for EX900 and EX1000 lamps taken at 1000 watts and 2-hour lamp age. Measurements for EX500 lamps taken at 500 watts and 24-hour lamp age.

Gaussian shape. Nevertheless, this approximation holds true only in the center of the focal spot. The outlying areas of the beam are higher in intensity than predicted by a Gaussian distribution. Figure 21 shows a typical Cermax® Xenon elliptical lamp beam shape. The x axis expands or contracts depending on the lamp type. The 10% focal spot diameter is 2.5 – 0.15 times the 50% focal spot diameter for almost all Cermax lamp types. Again, from lamp to lamp there is some variation in the shape of the curve, as well as a slight variation in shape from one lamp model number to another.<sup>16,17,18,19,20</sup>

The beam spot size and shape also vary with z-axis position relative to the nominal focal point of the lamp. The beam spot size also varies with lamp age. Figure 22 is a tabulation of these effects for a typical lamp.<sup>16</sup>

The figures mentioned above represent average data for relatively small sample sizes. For the reader to appreciate the statistical variation in the illuminance data, Figure 20 shows the distribution of illuminance values for a typical lamp type at 2 hours and at 24 hours. To complete the illuminance data, information on the shape and intensity distribution

Finally, Figure 23 shows how the spot illuminance varies with lamp age for a typical lamp. Other factors affect the lamp spot size and behavior. Factors mentioned in section 3.2 that affect arc illuminance

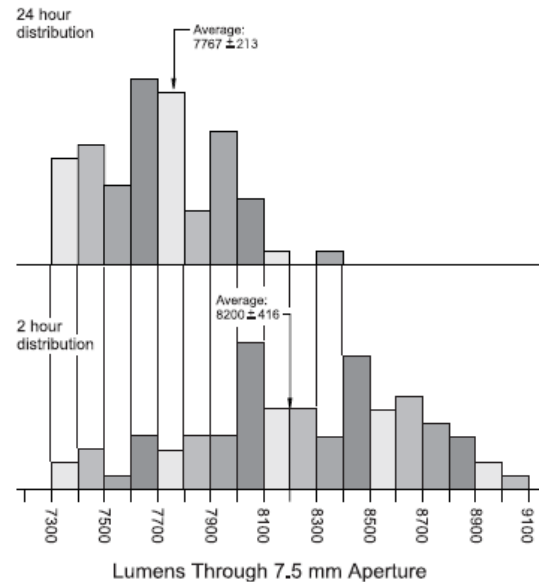

Figure 20: Typical output distributions of lamps at 2 hours and 24 hours (EX500-13F lamps).

also influence the spot size. Increasing the fill pressure and decreasing the arc gap cause the arc to become smaller and correspondingly cause the focal spot size to decrease. The lamp f-number is also a large factor, because the focal spot size is inversely proportional to the f-number. The ratio of illuminances between an f/1 and an f/1.3 lamp should theoretically be 1.7:1, because illuminance depends on focal spot area (f-number ratio squared). However, the measured illuminance differences between various f-number lamps of the same power are almost always smaller than expected. The lower-f-number lamps never quite achieve their small theoretical spot sizes because of reflector magnification issues.

Some lamp types have slightly different reflector geometries. Not all Cermax lamps have the same reflector collection efficiency. Therefore, scaling illuminance values from one Cermax lamp type and

wattage to another does not always work. This is particularly true as lamp wattage increases, because the hole in the back of the reflector around the anode changes in size. The hole must increase in size as wattage increases, to prevent reflector cracking. This hole is so close to the arc that it subtends a large fraction of the possible reflector collection angle.

Therefore, even though increasing arc power increases radiation efficiency, this increase is sometimes negated by the decrease in collection efficiency at higher power because of the larger anode hole size.

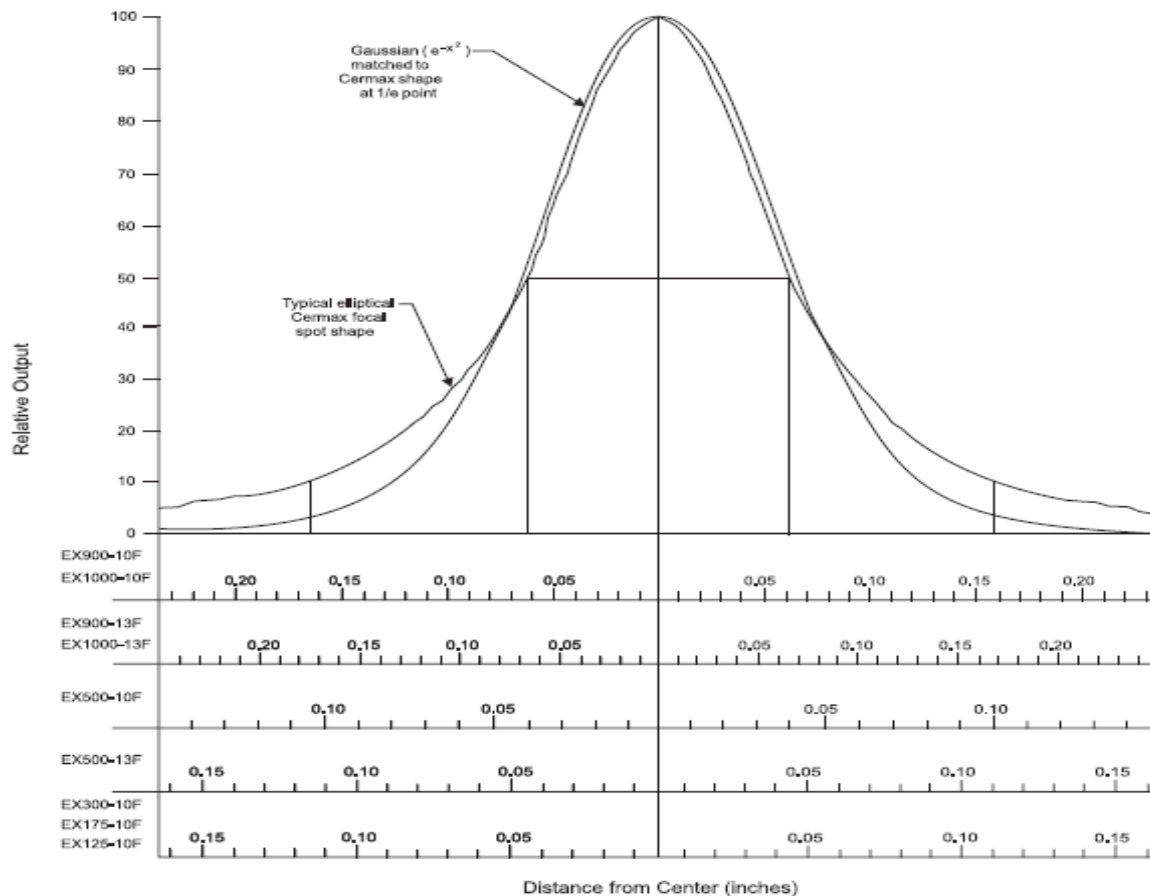

Figure 21: Typical elliptical Cermox beam shape compared to Gaussian distribution.

### 3.3.2 Parabolic lamps

All the same considerations of arc gap, fill pressure, and such, that are discussed in the preceding section relative to elliptical Cermox<sup>®</sup> Xenon lamps also hold true qualitatively for parabolic Cermox lamps with short-focus lenses. Figure 24 shows the equivalent number of lumens captured by various aperture sizes for typical parabolic Cermox lamps with lenses. The test method was similar to that described in section 3.3.1.

There are too many possible combinations of lamps, lenses, lamp age, and so on, to present complete sets of data for parabolic lamps with lenses. Section 3.4 presents data on parabolic Cermox lamp luminous intensities, that is, measurements of the unfocused output from parabolic lamps. That data, in conjunction with some simple lens calculations, enables the user to estimate the output from particular lamp-lens combinations. The data in Figure 24 can then be used to check the estimate. Parabolic Cermox lamps give lower focused

illuminance values than elliptical lamps of the same wattage. This is enough to avoid any damage to the

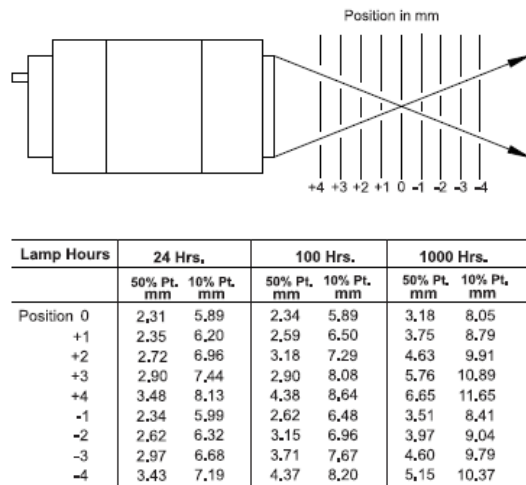

Figure 22: EX300-10F spot diameter as a function of z-axis position and lamp age.

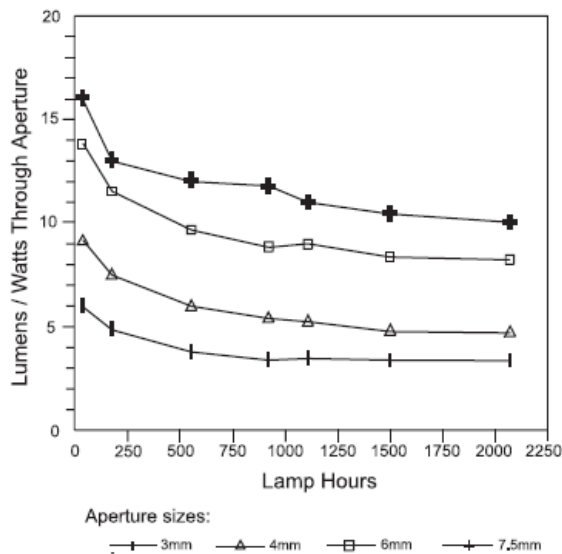

Figure 23: Spot illuminance as a function of lamp age and aperture size for an EX500-13F lamp at 500 watts, mostly a result of the lower reflector collection efficiency in parabolic lamps as compared to that of the equivalent elliptical lamps. Parabolic lamps still allow the user to match a particular fiber numerical aperture or system f-number without requiring a custom lamp reflector. Parabolic lamps also permit the user to insert optical elements such as filters in the parallel beam where the illuminance is low

element.

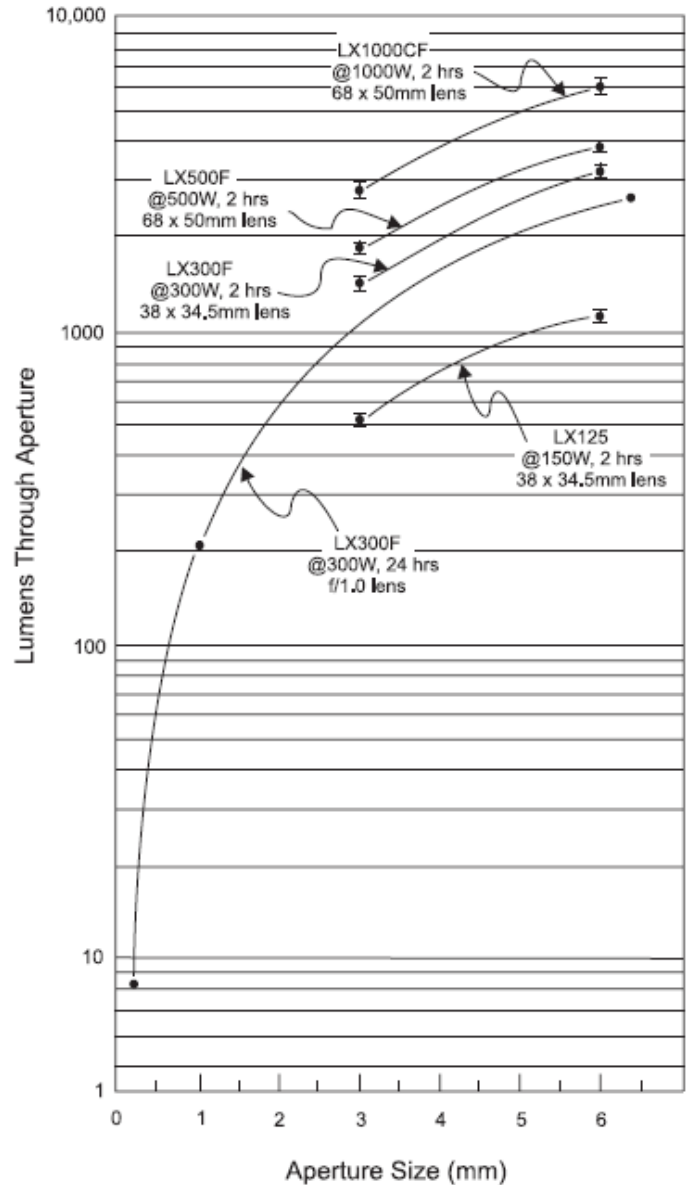

Figure 24: Lumen output versus aperture size for parabolic Cermax lamps with typical lenses. Lenses are aspheric condenser lenses.

An added variable when parabolic lamps and lenses are used is the lamp-to-lens distance. The focal spot shape and illuminance are functions of that distance. In most cases, the shorter the lamp-to-lens distance, the higher the illuminance at the focal spot.

Figure 25 shows a typical pinhole scan of the focal spot for an LX500F lamp and an f/1 lens. Again, there are lamp-to-lamp variations in the shape and some asymmetries attributable to the particular lamp.

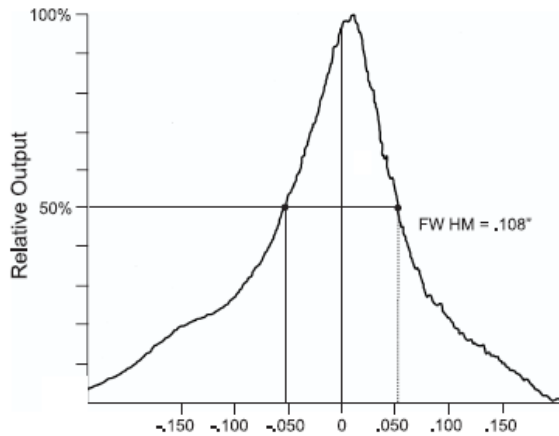

Figure 25: Typical pinhole scan of the focal spot of an LX500CF lamp with an f/1 lens.

However, there are some instances in which a longer lamp-to-lens distance is desirable. Because of the cathode obstruction on the axis of the lamp, there are no optical rays on or near the optic axis.

Consequently, when a lens is close to the lamp and focuses the output, there are no rays into the focal spot along the optic axis. This sometimes leads to a hole in the beam phenomenon, particularly if the focal spot being used is an image of the front window of the lamp. If the focal spot is an image of the lamp arc, there is no hole in the beam. An equivalent explanation is that the focused rays of the lamp are not smoothly distributed in angular directions.

Lamp	Total Lumens	Total Watts
LX125F	1500	17
LX175F	2200	25
LX300F	5000	50

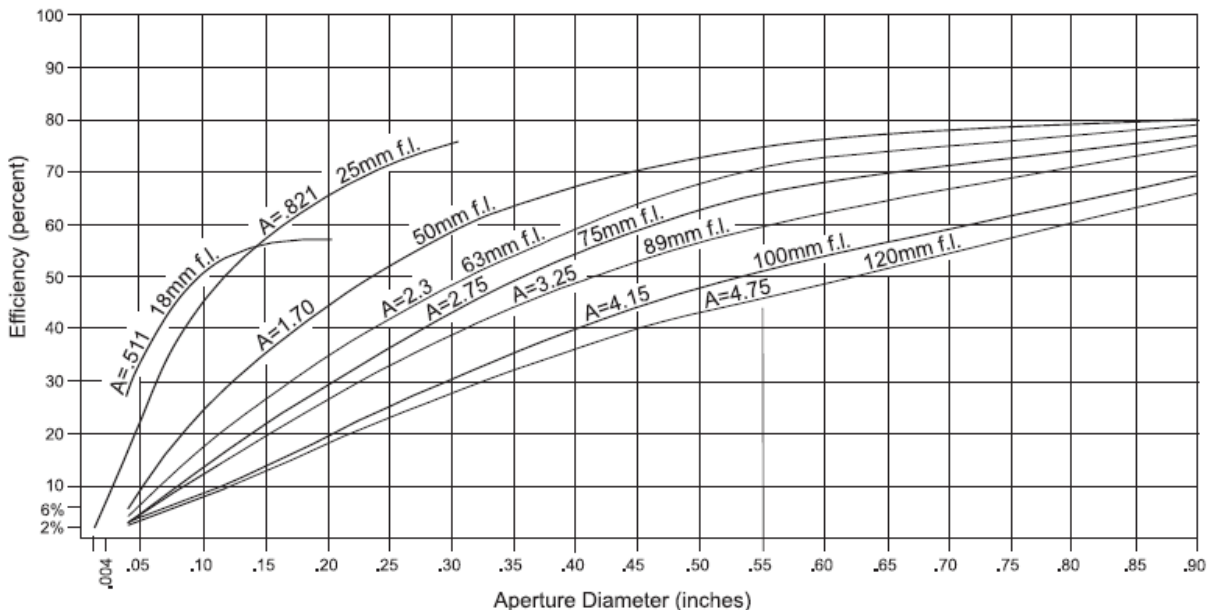
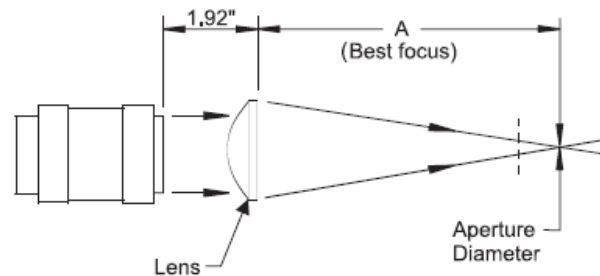

Figure 26: Graph for estimating the focused output of 1-inch parabolic Cermax lamps

Farther away from the lamp (typically 5 or more inches) so that the rays from the lamp have enough propagation distance to allow the rays from the side of the reflector to fill in the center of the focusing lens and smooth out the distribution of light incident on the lens.

Figure 26 provides a way of estimating the focused output of a 1-inch parabolic Cermax® Xenon lamp (LX125, 175,300) for a particular lamp-to-lens distance and for specific lenses. Cermax lamps were raytraced with various lenses and the predictions were checked by comparison to measured data. To use the figure:

1. Find the total lamp output (lumens or watts) from the table, or estimate the output if the lamp input power is not the nominal power for that lamp
2. Pick the lens-aperture combination from Figure 26 and read off the efficiency.
3. Multiply the output by the efficiency to arrive at the estimated illuminance for that aperture.

The figure shows that lenses with focal lengths longer than 2 or 3 inches are so inefficient that they are rarely used in practical systems for focusing Cermax® lamps.

### 3.4 Luminous Intensity

Luminous intensity is defined as the luminous flux per unit solid angle, where the unit is the lumen per steradian, or candela. Theoretically, luminous intensity applies only to point sources. For Cermax lamps, this means that the measurement must be made in the far field of the radiation pattern, usually a meter or more away from the lamp. Luminous intensity is the most important measurement for lamps used as searchlights. The candlepower of searchlights (measured in candelas) is often used as a measure of the power of such devices. Measuring the candlepower, and in particular the peak beam candlepower and unfocused beam shape of a parabolic Cermax lamp gives valuable information as to how well the lamp will perform. Not only does it tell how much useful light is emitted, but also how well the arc is positioned relative to the reflector and how well the reflector is figured.

The peak beam candlepower (PBC) and the beam shape are measured by shining the lamp over a long

distance and scanning a photodetector across the center of the beam. Figure 27 shows typical beam shapes for 300- and 1000-watt parabolic Cermax lamps.

### 3.5 Scaling Laws

Most of the information in section 3.0 was given for lamps operated at nominal power and in terms of photometric quantities. There are some general rules allowing translation of that data to other power ranges and other spectral regions.

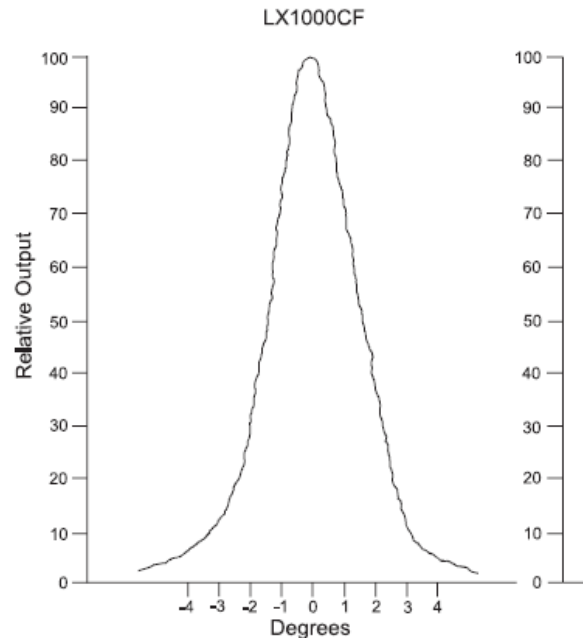
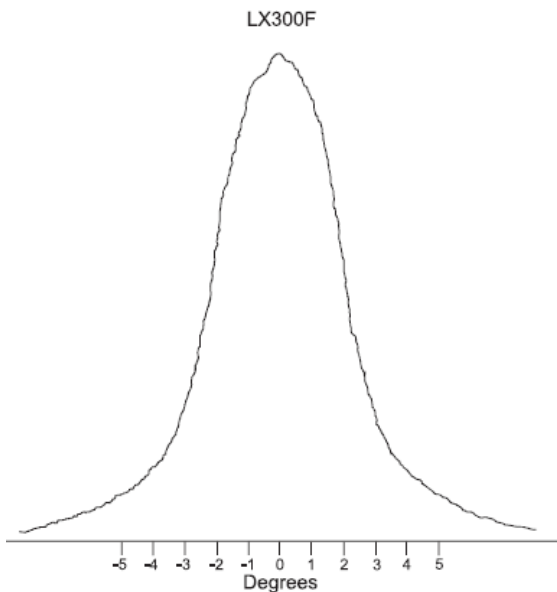

Figure 27: Typical farfield beam shapes of LX300F and LX1000CF Cermax lamps.

#### 3.5.1 Output versus input current

When lamp power is increased or decreased, it has been found that most optical measurements scale with the lamp current rather than with lamp power. The scaling relationship is as follows: Optical output is proportional to  $I^{14}/lamp$ . This relationship holds whether the optical output parameter is total lumens, illuminance, luminous intensity, or other spectral quantities of the same type. The only restriction is that the current can be changed only over the recommended lamp current range. Any spectrum change with current in the operating range is almost immeasurable.



### 3.5.2 Radiometric versus photometric quantities

Nearly all of the data presented in section 3 could have been taken in radiometric instead of photometric units. Luminance would have been radiance, illuminance would have been irradiance, and so on. The watt is the unit corresponding to the lumen in the radiometric system. Obviously, photometric units are most appropriate when the light will ultimately be used in a visual application, whereas radiometric units are more appropriate for uses such as materials processing and analytical instrumentation.

Because the spectrum of Cermax® Xenon lamps is relatively unchanged with lamp type and wattage and because it is uniform over the output beam, there is an approximate conversion factor from photometric to radiometric units. One hundred lumens correspond roughly to 1 watt with an accuracy of ~20%. To illustrate, assume a particular Cermax lamp gives 3000 lumens inside of a particular sized aperture. If the lamp were measured with a total optical power meter instead of a photometric integrating sphere, the result would be 30 watts in an aperture of the same size, assuming the lamp had no spectral filtering.

The result for UV Cermax lamps is very similar to that for F lamps, since the increased UV radiometric output is almost entirely compensated for by the reduced reflectivity of the aluminum mirror coating on the reflector.

### 3.5.3 Spectral quantities

Occasionally, spectral power densities are needed instead of photometric quantities. These power densities can be estimated from the available photometric data and the spectral distribution curve in Figure 10. The procedure is:

1. Let X equal the photometric quantity that needs to be converted to a spectral quantity (e.g., 3200 lumens in a 6-mm-diameter spot. See Figure 24).
2. Let Y equal the total lumen output for that lamp as given by the product specification sheet (e.g., 5000 lumens total from an LX300F lamp).
3. Let S equal the spectral power density as derived from the wavelength of interest in Figure 10 (e.g., 0.056 watts per nanometer at 530 nm for an LX300F lamp).
4. The spectral quantity that corresponds to the original photometric quantity is then  $XS/Y$  (e.g.,  $3200 \times 0.056 / 5000 = 0.036$  watts per nanometer in a 6-mm-diameter spot at 530 nm).

## 3.6 Other Optical Characteristics

### 3.6.1 Output variation with time

There are a number of phenomena that can cause slight temporal variations of the light output from both Cermax and quartz xenon arc lamps. Various technical papers have been written on characterizing these phenomena and developing schemes to stabilize the output of both quartz xenon and Cermax lamps.<sup>21, 22, 23</sup> To distinguish the phenomena, the resulting temporal light variations have been given distinct names.

The first is AC ripple, which is caused, as one might expect, by mains frequency ripple leaking through the power supply onto the lamp current or voltage. If the AC ripple is on the voltage, it is less noticeable than on the current because arc lamps have a very flat V-I curve (see section 4.1). If the AC ripple leads to excessive ripple on the light output, it is necessary to increase the power supply filtering. In some power supply circuits, the AC ripple can be reduced by actively feeding back an error signal and modulating the power supply current to subtract out the ripple.

A related effect is caused by magnetic fields. A magnetic field can move and modulate the lamp arc. Sometimes this is caused by a transformer or even by placing the lamp cooling fan motor too close to the lamp arc.

The second major temporal effect is flicker in the light beam. This is caused by very small, sometimes microscopic, movements of the arc on the cathode tip. It can sometimes take the form of a periodic light modulation around 40 Hz, or it can take the form of a sudden rise or drop of a few percentage points in the light output, occurring anywhere from once every few minutes to once an hour. In flicker, the total light output of the lamp modulates up and down so that combining and integrating the light from various parts of the lamp does not resolve the problem. In Cermax lamps, flicker is less than 6% peak-to-peak and is typically on the order of 3–4%. There is an effect related to flicker, called flashing. In this phenomenon, the light output flashes to a higher level for a short period of time and then goes back to the original level. Flashing is rare and is caused by microscopic damage to the cathode tip in the lamp.

The third effect is shimmer. If the light from an elliptical Cermax lamp is allowed to expand and shine on a surface 1 or 2 meters away, there will be a large illuminated area where the light shimmers, similar to light going through air rising from a hot surface. This is caused by variable refraction of light throughout the convectively flowing xenon gas in the lamp. Shimmer does not appear in applications where the light from different parts of the lamp is mixed in either a fiberoptic lightguide or an optical integrator, but usually appears in visual systems where no integrators are present. There is no known way of eliminating this effect in the lamp. Peak-to-peak variations of the light on a very large illuminated surface from a lamp exhibiting shimmer can be 10–20%. An effect related to shimmer is the instability in output of a Cermax® lamp when the lamp is run with the window pointing upward. Running a Cermax lamp in this position is not recommended, except at very low powers, because the hot xenon gas from the arc rises directly to the window and can overheat the window. However, even when the lamp output points within 45 degrees of vertical, the output will become unstable because convection inside the lamp will disturb the arc.

Often, a number of the effects mentioned above combine in particular optical systems. For instance, when shining a parabolic Cermax lamp on a photodetector in the far field of the lamp, flicker and shimmer usually combine to give a 5–10% variation in the detected light at the center of the beam. It is difficult to define a good universal test for the

temporal variations discussed here. Most practical optical systems mix the light to some degree; often, they contain detectors that have a variable frequency response. The human eye is sensitive to variations of more than 10% when they occur below 30 Hz.

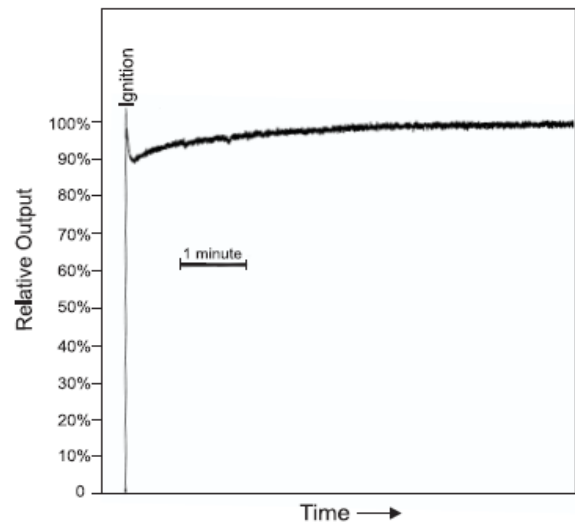

Figure 28: Output of EX300-10F lamp as a function of time after ignition. Width of trace indicates typical output stability.

### 3.6.2 Turn-on characteristics

Cermax and quartz xenon arc lamps immediately turn onto approximately 85–90% of full power and then increase to 100% over the next 15 minutes. Figure 28 shows a typical warm-up curve. During the warm-up, the lamp spectrum, the focal spot size, and other optical characteristics do not change noticeably.

## 4.0 Electrical Characteristics

The electrical characteristics of quartz xenon arc lamps and Cermax lamps are complex.<sup>24</sup> Characteristics such as the voltage-current (V-I) curve, triggerability, dynamic resistance, and so on, are affected by a large number of lamp variables that result from numerous interactions between plasma and materials inside the lamp. In addition, electrical characteristics vary slightly from lamp-to-lamp and with lamp age. These characteristics are nonlinear and many exhibit memory effects.

Fortunately, the best xenon lamp power supplies and electrical interfaces are robust and are tolerant of slight lamp-to-lamp variations, so most of the complex interactions are not important to practical circuits. In addition, Cermax and quartz xenon lamps



are not grossly temperature-sensitive, so their electrical characteristics do not change radically during lamp warm-up as they do with mercury and metal halide lamps. Most of the lamp's electrical variability is attributable to effects at the lamp cathode: either the activation of the cathode tip or the manner of arc attachment. All other electrical lamp variables anode condition, fill pressure, and arc gap are so well controlled that they do not cause problems of variation from lamp to lamp.

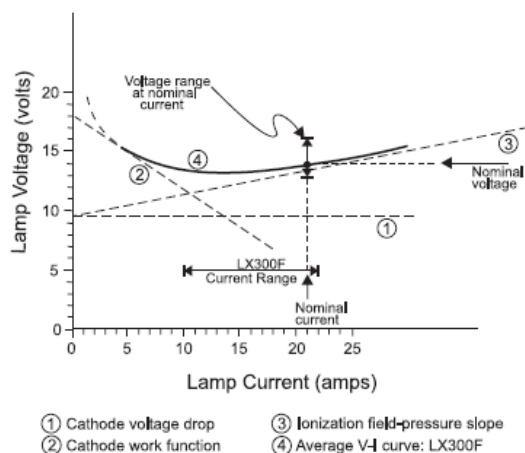

Figure 29: Average V-I curve for the LX300F lamp. See text.

#### 4.1 V- I Curves

The primary electrical characteristic of a Cermax or shorter clamp is the V-I curve. Figure 29 shows the average V-I curve for the LX300F lamp. This curve is derived from the actual average lamp voltage and current as measured after lamp ignition and while lamp current is slowly varied. Superimposed on the V-I curve are three asymptotes that explain how the curve results from lamp parameters.<sup>25, 26, 27</sup>

Asymptote 1 arises from the voltage drop at the cathode. It represents the voltage necessary to power the cathode and raise the cathode tip to the necessary temperature for thermionic emission. With a thoriated tungsten cathode, it is very difficult to build a lamp with less than a 10-volt drop, even with a vanishingly small arc gap, because of the need for power to raise the cathode to its operating temperature.

Asymptote 2, which determines the negative resistance portion of the curve, is a measure of the relative ease with which thermionic emission takes place at the cathode. This curve is affected by fill pressure and by the activation at the cathode tip. A high fill pressure causes asymptotes 1 and 2 to intersect at lower currents. A cathode that is new

and well activated will also cause the intersection to occur at a low current. As a lamp ages and the cathode tip becomes worn, the minimum in the V-I curve tends to move to higher currents.

Asymptote 3 is primarily determined by the ratio of the electric field to the gas fill pressure. The slope of asymptote 3 is a function of the lamp's cold fill pressure. A higher fill pressure causes a steeper slope.

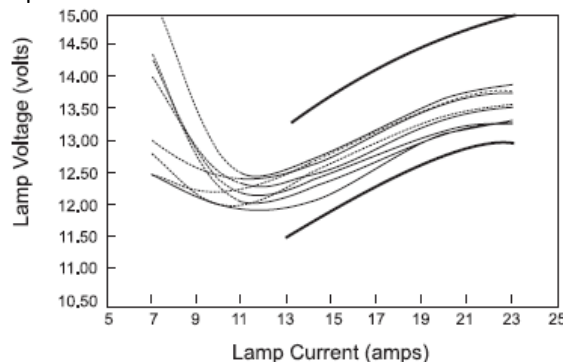

Figure 30: Individual V-I curves for the EX300-10F lamp after 2 hours. Bold lines indicate normal range of voltages

As we have mentioned, the upper end of the operating range of a Cermax lamp is determined by the maximum power loading or the maximum safe operating temperature to achieve rated life. The lower operating current limit is determined by the minimum current needed to keep the lamp cathode activated and free of arc flicker. The minimum current in most lamps tends to correspond roughly to the minimum in the V-I curve. At currents lower than the curve's minimum, the cathode no longer operates at the proper temperature, the cathode hotspot is more diffuse, the arc is less stable at the cathode tip, and, because of the negative resistance, the lamp's operation can be unstable. In addition, the lamp will emit EMI at these low currents.

Figure 30 shows actual individual V-I curves for a number of EX300-10F lamps after 2 hours of operation. Figure 31 shows the equivalent curves for EX900-10F lamps.

As lamps age to their rated lives and the minima of the V-I curves tend to move to higher currents, the lamp voltage distribution tends to spread out to higher voltages, because the cathode tip burns back and becomes slightly less active, causing a longer effective arc gap in some lamps. The slopes of the linear operating regions of various lamp types vary with fill pressure. Lamps with a 250-PSI fill pressure

(LX125, 175, 300) have an average slope of 0.08 – 0.02 volts per amp. Lamps at 280 to 305 PSI (LX500, LX1000, EX500) have an average slope of 0.12 – 0.02 volts per amp. Lamps at 325 to 350 PSI (EX125, 175, 300, 900) have an average slope of 0.2 – 0.03 volts per amp.

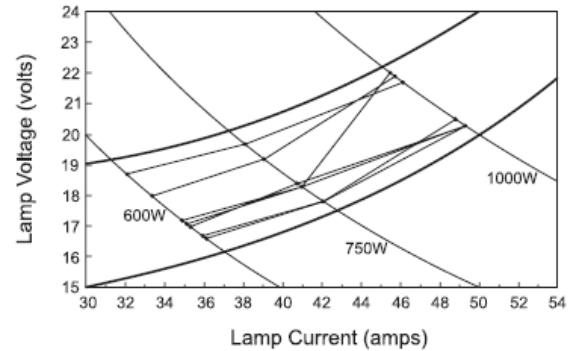

Figure 31: Individual V-I curves for the EX900-10F lamp after 2 hours. Bold lines indicate normal range of voltages

#### 4.2 Lamp Ignition

Lamp ignition is the process by which the initial, cold, non-conducting gas in the lamp is changed by the application of electric fields and current sources to a conducting stable plasma at the lamp’s running current. As with other lamp characteristics, calculating anything in the ignition process from plasma parameters is not practical. Most such calculations do not allow advance prediction of useful information.

The ignition process covers many orders of magnitude in voltage and current, from volts to tens of kilovolts and from microamps to tens of amps. For convenience, the process is separated into three sequential stages: trigger, boost, and DC. In section 4.4, on power supplies, a typical circuit for these stages is shown.

The ignition process creates a great deal of electrical noise, sometimes at very high frequencies. This noise is caused by the high voltages and high currents in the process. In cases where sensitive electronics are fairly close to arc discharge lamps, the system should be designed so that either (1) the sensitive electronics are extremely well shielded from radiated and conducted EMI at the lamp and at the lamp power supply, or (2) the sensitive electronics are turned on only after the lamp has been ignited.

##### 4.2.1 Trigger

Lamp ignition requires the application of a high-voltage DC or trigger pulse to one of the lamp electrodes. The high voltage initiates a trigger streamer between the electrodes and causes the streamer impedance to decrease enough for the next stage in the process, the boost phase, to take over and supply even more energy to the discharge.

It is possible to ignite Cermax® Xenon lamps with high-voltage DC, either from a separate DC supply or from a voltage multiplier. Such DC ignition is rarely used because of the economics of circuit design. It is usually easier and less expensive to design a pulsed circuit to supply a short trigger pulse. Also, there is a risk with DC ignition: in Cermax lamps it is possible to ignite the gas between the anode and the reflector instead of the gas between the anode and the cathode. Such an arc-over ignition mode, which is ultimately destructive to the lamp, is most often seen in older lamps with either DC ignition systems or systems in which the ignition pulse rises slowly.

The voltage required to trigger the lamp varies with the time over which the voltage is applied. The shorter the time over which the voltage is applied, the higher the voltage required for breakdown. On a DC basis, an LX300F Cermax lamp may trigger at 7 to 10kV. However, it may require a 13-kV peak pulse with a 250-ns pulse width to break down the gas in the same lamp.

Each Cermax product specification sheet includes a value for the recommended minimum ignition voltage at the lamp. This value is in the range of 17 to 35 kV. This recommended voltage represents the minimum value that a circuit designer should use in designing a lamp power supply to ensure that the lamps ignite and run throughout their full lifetimes. It is assumed that the designer is using a trigger pulse in the 20-ns to 1- s range. The vast majority of Cermax lamps produced will actually trigger at voltages much lower than this recommended value. However, conservative designs for igniters go even farther. Additional factors can degrade triggerability so that even a higher trigger voltage design point may be required:

- Most trigger circuits vary from unit to unit because of spark gap and transformer variations.
- With fast trigger pulses, the lines between the igniter and the lamp can degrade the trigger pulse by capacitively shorting out part of the trigger pulse.
- Cermax lamps require slightly higher than normal trigger voltages for 1 minute after being turned off. If extra trigger voltage is designed into the circuit, it allows the lamp to trigger reliably even in this hot restrike situation.
- One of the possible end-of-life phenomena in Cermax® lamps is failure to trigger. This can be caused by gas contaminants that evolve from interior lamp parts during operation. If a lamp has exceeded its rated lifetime and still provides acceptable light output, yet requires a higher trigger voltage, additional free life can be obtained by making sure that the trigger voltage is high enough to run these lamps.

The only drawback of designing an extremely high trigger voltage is the possibility of arc-over to other

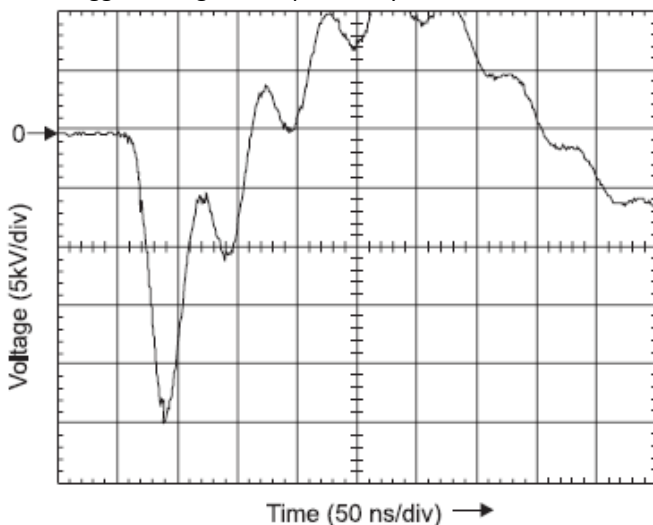

components in the system if the lamp fails to trigger. Thirty- to 45-kV peak trigger voltage is a good design range for most lamps if the insulation is sufficient.

Figure 32 shows a typical lamp trigger pulse. When the trigger circuit is connected to a lamp, the rising edge of the first pulse breaks at the lamp trigger voltage and the rest of the ringing waveform is clamped to zero.

The amount of energy in the trigger pulse is not crucial. In fact, low energy is recommended for safety. For example, 0.02 J in the primary discharge

circuit is sufficient for low-power Cermax lamps, and only a small fraction of this energy is actually deposited in the lamp. Likewise, the exact condition of the electrodes making the transition from non-conducting to the point of breakdown of the lamp is unimportant. It is very rare that a lamp does not trigger if the trigger voltage is within specifications.

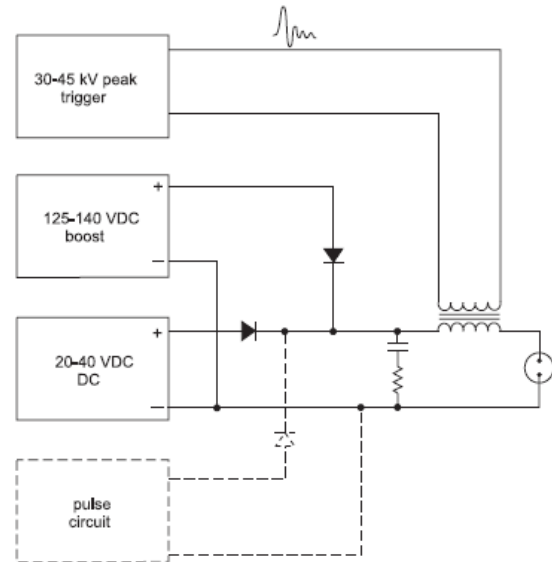

Figure 33: Typical lamp ignition circuit.

Either the anode or the cathode of a Cermax lamp can be triggered as long as:

- The trigger polarity matches the electrode potential (i.e., positive pulses if anode triggered and negative pulses if cathode triggered).
- The insulation at the triggered electrode is sufficient.

For some applications, anode triggering is favored because it allows optical components closer access to the lamp window (cathode end) without the risk of high voltage arc-over. Xenon lamps can exhibit triggerability differences that are related to the time between ignitions. Lamps that have been stored for weeks or months may be slightly harder to start the first time. This condition may occur because residual charge carriers inside the lamp, which normally aid ignition, recombine during long periods of inactivity. It may also be caused by very small amounts of oxidation on the cathode tip or by contamination of the xenon with an electronegative gas such as hydrogen. On a very short time scale, lamp triggerability is subject to an effect termed hold-off.

Just after a xenon lamp is turned off there is a time period, usually measured in milliseconds, during which the lamp will still retain some ionization and therefore will be very easy to reignite.

The lamp will not be capable of holding off a high voltage. This effect is not very important in xenon arc lamps, because reigniting or holding off a high voltage on such a short time scale is not normal.

In summary, the variables that can affect lamp triggerability are

- Peak voltage
- Pulse rise time or pulse width
- Capacitive loading of the lamp leads

- Hot or cold restrike
- Time since last ignition
- Age of lamp
- Impurities in the gas

#### 4.2.2 Boost

The boost phase of ignition widens the narrow discharge streamer generated in the trigger phase. By depositing more energy in the streamer, the boost drives the impedance of the arc low enough for the DC phase of ignition to take over. The aim is to drive the lamp to the positive portion of the V-I curve.

Figure 33 shows a schematic diagram of the lamp ignition circuit, including the boost and the

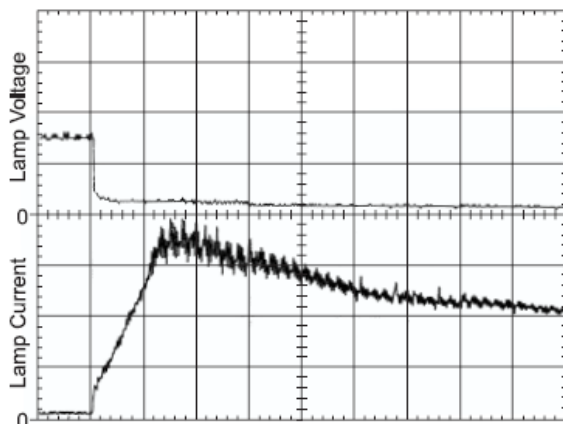

(a)

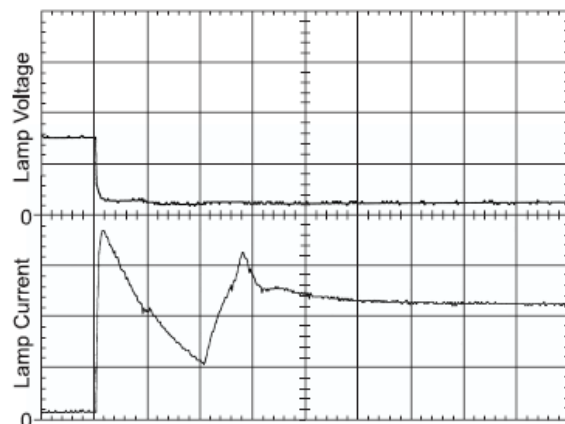

(b)

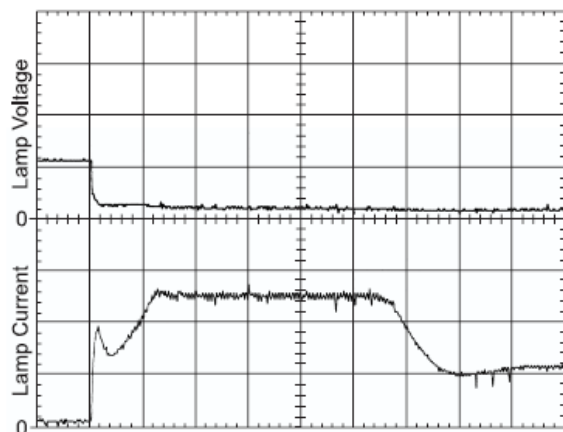

(c)

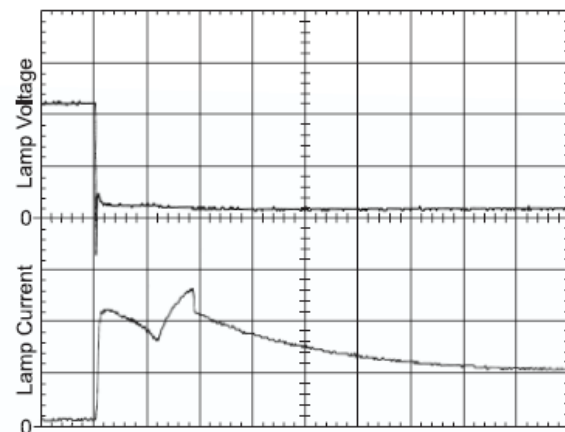

(d)

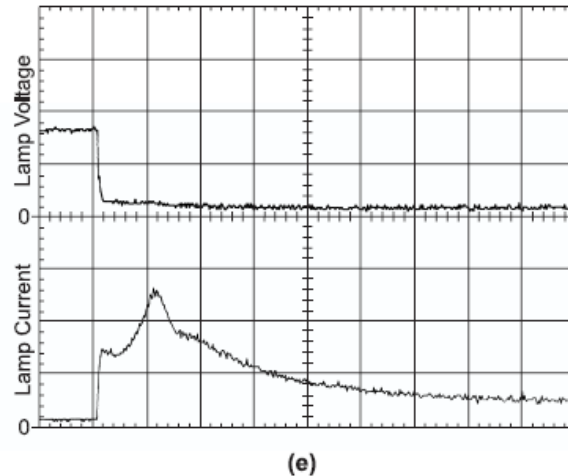

Figure 34: Typical voltage and current waveforms during ignition of Cermax lamps. Time base 500 msec per division. Lamp voltage 100 volts per division. Trigger occurs after first division. (a) PS175SW-1 power supply, 10 amps per division. (b) PSC300 power supply, 10 amps per division. (c) PS300SW-2 power supply, 20 amps per division. (d) PS 300-1 linear supply, 20 amps per division. (e) PS500-10 power supply, 50 amps per division.

trigger. The boost and DC phases of ignition interact much more strongly with each other than with the trigger phase. Most problems in lamp ignition are problems in the boost and DC circuits. In practical, economical power supply designs, the boost is rarely a separate circuit. It is usually designed into the DC section. The trigger circuit in practical circuits may be separate, but even the trigger circuit is usually powered by voltage from the DC section.

The boost is usually designed with one of two approaches. In the first approach, voltage is stored on a capacitor that is connected to the lamp with a resistor in series. The lamp then forms an RLC circuit and when the trigger pulse breaks over the arc gap, the RLC circuit discharges through the lamp. This type of circuit is shown in Figure 33. The result is a current pulse through the lamp that reaches a peak current higher than the lamp running current. The circuit values are chosen to reach the optimum peak current and duration. These values are usually determined by trial and error with a number of sample lamps. The goal is a discharge that smoothly makes the transition to the lamp running current on the decreasing current side of the boost pulse.

In the second approach, there is still a voltage source and usually a charged capacitor to supply most of the current, but instead of an RLC circuit, active devices such as FETs or transistors are used to limit and shape the boost discharge into the lamp. In this

approach, there may not be an apparent boost pulse, because the current may rise smoothly from zero up to the final lamp running current. Either of these approaches produces reliable lamp ignition if the design is correct, so a wide range of lamp variation can be accommodated. A number of factors affect the boost discharge: peak voltage, peak current, stored energy, rise time, fall time, transition to the DC phase, and the impedance of the lamp. The most important parameters are peak voltage, peak current, and the transition to the DC phase.

The minimum recommended peak voltages for reliable boost are 125 VDC for lower-powered Cermax lamps of 300 watts or less and 140 VDC for the higher-powered Cermax lamps (500 watts and above). It is possible to design reliable boost circuits with values lower than these, but these represent the lowest values for conventional circuits. Higher boost voltages are better as long as the maximum boost current is observed.

Peak boost current is important primarily because excessive peak current can damage the lamp electrodes. Because some successful boost circuits make the transition to the running current smoothly, there is obviously no minimum acceptable boost current. Nevertheless, above a 400-amp peak in a boost current pulse of less than 1 ms, the cathode may be damaged. For boost current pulses of longer

than 1 ms, even 400 amps may be excessive. Figure 34 shows some typical boost voltage and current waveforms from commercially available power supplies.

#### 4.2.3 Transition to DC operation

The DC power supply must satisfy four primary requirements to successfully take the lamp from the boost phase into steady DC operation. First, the DC supply must either be current-regulated or change from voltage regulation to current regulation as it takes over from the boost circuit. Voltage regulation in normal operation is not recommended because the lamp V-I curve is too flat. Second, the rise time of the DC circuit must match the time constant of the boost circuit. The DC circuit must take over the supply of lamp current in a smooth manner. For instance, if the boost current decays away in 1 ms, the DC circuit must have a rise time of at least 1 ms. If there is a pronounced dip in current between the boost and the DC, the lamp voltage may go up and the lamp may be extinguished. Third, the DC circuit must have sufficient open circuit voltage. From Figure 34, it is apparent that even with sufficient current, the lamp voltage is higher than the normal operating voltage for a short time after lamp trigger and boost. For low-wattage lamps, 20 volts are often needed for a few milliseconds after the boost. For higher-wattage lamps (500 watts and above), 35 to 40 volts are often needed. The exact requirement is a function of the energy and time constants in the boost circuit, the particular lamp type and lamp age, and the load characteristics of the DC supply.

The last requirement is low-ripple current at mains line frequencies. This is not really a requirement for reliable lamp ignition, but for achieving rated lamp life. Fifty- to 120-Hz current ripple should be limited to 10% or less. Above 10% low-frequency ripple, the lamp's lifetime is usually reduced, because the lamp cathode temperature cannot stay constant for good thermionic emission. Five percent ripple is a good design goal. However, high frequency ripple can be greater than 10%. At normal switching power supply frequencies (40 kHz and above), the cathode is not disturbed as much by the fast oscillation in power and can, therefore, tolerate higher ripple. The exact limits are unknown, but a 15% ripple current at 50 kHz does not seem to affect lamp life.

### 4.3 Lamp Modulation, Pulsing, and Flashing

There are three modes of time-varying lamp current in Cermax and quartz xenon arc lamps. Modulation means varying the lamp current between the lower and upper limits of the normal DC current rating. Pulsing means making the lamp's current higher than its normal operating current for a short period of time, then returning the current to a low, or simmer, level before the next pulse. Cold-flashing means changing the lamp current from zero to a high value, and then back to zero.

#### 4.3.1 Modulation

Applications that may involve modulation of Cermax lamps are:

1. Stabilization of the lamp's output by feeding back error signals to correct output instabilities.
2. Military infrared countermeasures in which time varying lamp output is required to disturb optical tracking systems in missiles.
3. Compensating light levels for three-color sequential video systems.
4. Signal transmission.

Application 1 involves modulating the light level only at a very small level and at low frequencies.

Applications 2, 3, and 4 usually involve a high depth of modulation and kHz frequency ranges.

The electrical circuit required to achieve lamp current modulation is normally built into most lamp power supplies. Because most supplies are current-regulated, there is usually a circuit that senses lamp current and feeds back a voltage proportional to the current, so the power supply automatically stays regulated at the required current. Adding modulation to such a supply requires breaking into the current feedback loop so that a modulation signal can be added to the current regulation signal. Some type of optical or transformer isolation is desirable to prevent dangerous voltages and currents from occurring in the signal input circuitry.

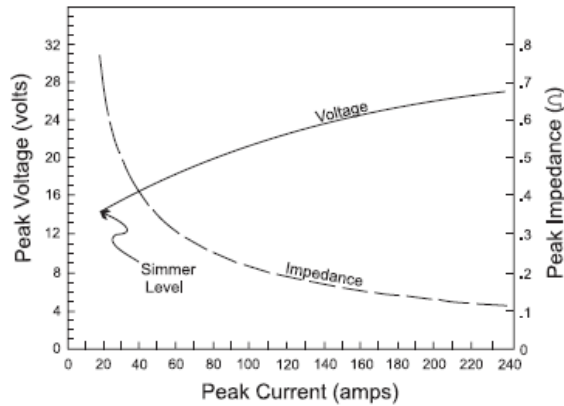

Figure 35: Typical Cermax lamp V-I and impedance curves for pulsing (LX300F).

The frequency and depth of modulation are determined by two phenomena: premature lamp darkening and acoustic resonances. Premature lamp darkening is caused by changing lamp current and cathode temperature too quickly. We mentioned this effect in Section 3.6.1, in the discussion of lamp ripple current. At low depths of modulation, 20% peak-to-peak variation, and at 60 Hz, the cathode temperature stays sufficiently constant that lamp darkening is minimal. The lamp's lifetime may be shorter than the normal 1000 hours, but will be at least 300 hours. At high frequencies, at which the thermal time constant of the cathode tip is much longer than the period of the modulation, the peak-to-peak variation or depth of modulation can be higher.

Acoustic resonances are frequencies of modulation at which acoustic waves inside the lamp disturb the lamp arc.<sup>28</sup> Sometimes the resonances distort the arc and give it the appearance of a vibrating string. More often, the resonance simply causes the arc to be unstable at that frequency. The resonances are not found in narrow frequency bands, but may cover a range of many kHz. Resonances also vary from lamp type to lamp type and also between nominally identical lamps. In general, the resonance frequency is proportional to the fill pressure and inversely proportional to the arc gap and the lamp size. In Cermax lamps, these resonances occur above 5 kHz. The degree to which a resonance disturbs the arc is highly dependent on the depth of modulation at that frequency. For example, in a 1000-watt Cermax lamp, there are no resonances below 6 kHz. At 66% depth of modulation above 6 kHz, it is very difficult to find a frequency at which the lamp will not be

extinguished because of acoustic resonances. However, at 33% depth of modulation, the same lamp can reach 14 kHz before resonances cause it to be extinguished. Lower-wattage Cermax lamps have the resonances at higher frequencies. Square-wave or sine-wave modulation produces approximately the same results. For these reasons, most Cermax and quartz xenon arc lamps are rated for modulation from 0 to 5 kHz.

The lamp response to a step function change in current is complex.<sup>29</sup> When a current change is forced on the lamp, the cathode must produce more charge carriers and these must propagate across the arc gap. The speed of this process is influenced by the voltage across the arc. A higher voltage is needed to sustain a quick production of charge carriers and to drive these charge carriers along the arc. Therefore, the rate of current rise in the lamp is a function of the applied voltage. With the normal voltages available in most supplies, 20 to 25 V, and with a series inductance of about 50 microhenries (trigger transformer inductance), the current rise time is usually 200 s. Without the trigger transformer inductance, the rise time decreases to 100 s. Increasing the available lamp voltage to 37 V causes the rise time to decrease further, to 20 s. With a high enough voltage, in the hundreds of volts, the current rise time can be a few microseconds. The lamp's light output follows the current pulse with only a few microseconds delay in all these cases. Because of the charge carrier production (described above), the V-I curve for a modulated lamp is complicated. At low frequencies, the lamp traces the same curve as its current rises and falls. At high frequencies, the lamp traces a loop on the V-I curve.

Every Cermax lamp can be modulated over its recommended operating current range. Because of the cathode temperature problems we have mentioned, running below minimum current and at more than 20% depth of modulation is not recommended for long-term operation because these practices shorten the life of the lamp. However, it is possible to modulate Cermax lamps with modified power supplies down to very low currents and up to 90% modulation depth.

#### 4.3.2 Pulsing

Applications that involve pulsing of Cermax lamps are

1. Photographic exposure, either with the direct beam or through a fiberoptic lightguide.
2. Materials processing involving local heating of a part.

In both applications, the goal is to achieve the highest possible short-term light levels and also to achieve an acceptable lamp lifetime. Most of the available test data on pulsing concern the LX300F lamp. However, other lamps are equally capable of pulsing and the LX300F data can be used to estimate their performance.<sup>30, 31, 32</sup>

The same considerations we have discussed in connection with simmer levels, peak currents, rise times, and V-I characteristics apply in the case of pulsing. The lamp should be simmered between pulses at a current in the normal operating range. The maximum average power of a lamp, including the pulse power, should not exceed the lamp's maximum average power rating, even though the peak power may reach 2000 watts during the pulse. The pulse rise time and optical rise time will depend on the open-circuit voltage available. The lamp V-I curve stays unchanged, except that the V-I curve is extended to higher currents (see Figure 35).

The peak current during the pulse should not exceed 400 amps, even for pulses on a millisecond time scale. The maximum peak current for pulses in the 1- to 100-ms range is 300 amps. At a duration of 1 second, the maximum peak lamp power is 600 watts. It is possible to attain peak currents higher than these levels. However, to do so requires the use of a larger lamp body and electrodes, the design of special lamp electrodes for the particular pulse, or at least extensive testing under these extreme loads to determine the effect on lamp lifetime.

At 100-ms pulse width, a 100-amp pulse allows the lamp to achieve a respectable 30,000-pulse lifetime to half-light output. In this 100-amp, 100-ms example, the pulse energy is 200 J and the pulse is repeated every 1.5 seconds. The interpulse simmer is set so that the average lamp power is 300 watts. In this example, the pulse stays at 100 amps during the entire pulse.

The light output from a Cermax lamp pulse follows the current pulse with only a few microseconds

delay. Because of the cathode emission process, mentioned in Section 4.3.1, if a current-regulated pulse is used, the lamp voltage will initially overshoot to start the charge carrier formation in the gas. The light output spectrum during the pulse will shift to a higher color temperature as the pulse current increases. This is caused by the higher power density in the arc during the pulse and also by the increased plasma emissivity during the pulse. Because of the spectral and emissivity shifts, and because of the large peak-to-simmer current ratio, the normal scaling rule for light output with current must be modified. At peak currents up to 50 amps, the scaling rule becomes  $I^{1.6}$ . At higher currents, saturation appears to be reached and the output becomes more linear with current; that is, the exponent of 1.6 decreases again. Because of the high peak currents and the resulting increase in color temperature, the ratio of UV to visible light increases as the pulse current increases.

After the current pulse has ended, the radiation from the xenon gas decays away with a 100- to 400-s time constant. The UV terminates faster than the visible, which, in turn, terminates faster than the infrared. This afterglow, which we have mentioned, is caused by delayed emission from meta-stable states in the gas.

During these high peak current pulses, the arc expands. As a result, the minimum attainable focal spot is larger, sometimes three times larger than when the lamp is run at normal current levels.

#### 4.3.3 Circuits for pulsing

Pulsing normally requires adding a separate circuit to a normal lamp power supply. Figure 33 shows how such a circuit is normally connected to the rest of the supply.

Pulsing circuits can be classified in a number of different ways:

1. Simple RLC circuit. In its simplest form, the pulsing circuit can consist of a charged capacitor and either an inductor or a resistor limiting the current pulse. A switching means, such as an SCR, is required to initiate the pulse. The current pulse from such a circuit is highly nonlinear and difficult to control, and is therefore rarely used.
2. SCR circuit with commutation. The next-highest level of complexity is reached by adding an SCR to the simple RLC circuit to turn the pulse off at the required time. The commutation SCR circuit usually produces a current pulse that sags toward



its end, because the voltage on the storage capacitor decreases. However, with a very large storage capacitor, the sag can be small.

3. FET or Darlington transistor circuit. More modern circuits use an FET or a high-current transistor to switch the pulse on and off. A charged capacitor (40 V on a 100,000- f capacitor) is still required. The current during the pulse can be actively regulated or not. This is the most common type of circuit used in commercial pulsing circuits, because it offers reliable, controllable pulsing with an economical circuit.
4. Complete high-current power supply. The pulse current can be obtained from a high-average-power current-controlled power supply that operates at a small duty cycle to supply the pulse current. Though uneconomical, this approach does achieve a high degree of regulation during the pulse.

Engineering Note 229 shows the schematics for some of these circuits, as well as circuits for common lamp power supplies.

#### 4.3.4 Cold flashing

Cold flashing is not recommended for normal Cermax® Xenon lamps unless shortened lifetime is not a concern. In cold flashing, the lamp acts as a pulsed short-arc lamp. Peak currents of 1000 amps for 2 to 15 s are achieved. The spectrum shifts heavily to the blue and UV. The peak intensities are very high, but the average efficiency of the lamp is very low because the circuits used to achieve these high peak currents are inefficient. Special Cermax lamps with cathodes that do not rely on thermionic emission have been developed for this application.<sup>33</sup>

#### 4.4 Lamp Power Supplies and Igniters

Sections 4.1 and 4.2 provide the necessary information for a power supply designer to design a reliable Cermax or xenon arc lamp power supply. Most such power supplies are not made by

modifying existing low-voltage power supplies. Most arc lamp supplies are custom designed.<sup>34</sup>

Engineering Note 229 includes representative schematics for commercial Cermax power supplies and a checklist of specification items to be addressed when such supplies are designed. Before the advent of large-scale integrated circuits, power-regulated arc lamp power supplies were difficult to design and lamp-power supplies tended to be current regulated. Current-regulated supplies work very well and most xenon arc lamp supplies today are current regulated. However, power regulation is slightly preferable. When a Cermax lamp ages, it tends toward higher voltage operation because the cathode tip wears and the arc gap lengthens. Therefore, if the power supply is current regulated, there is a slight chance that later in life the lamp will run at a power that is higher than its original setting or higher than its maximum power rating. Power regulation avoids this problem. Under no circumstances should a voltage-regulated supply be used unless a large ballast resistor is included in the lamp circuit.

Figure 36 shows a typical xenon arc lamp power supply, including the igniter and the boost. The particular circuit shown here would be termed a forward, or buck, converter. Although this circuit is one of the simplest and most reliable arc lamp power supplies, it is shown here only as an example. Other references treat the detailed design of switcher power supplies.<sup>35, 36</sup>

In Figure 36, the AC mains voltage is input at E1 and E2 and rectified by BR1, and the voltage is stored on C4. The main switching element is Q7. When Q7 is conducting, current flows through L1, producing an output voltage across the lamp with the correct polarity. Diode D4, sometimes referred to as the flywheel diode, is reverse biased because of the voltage polarity.

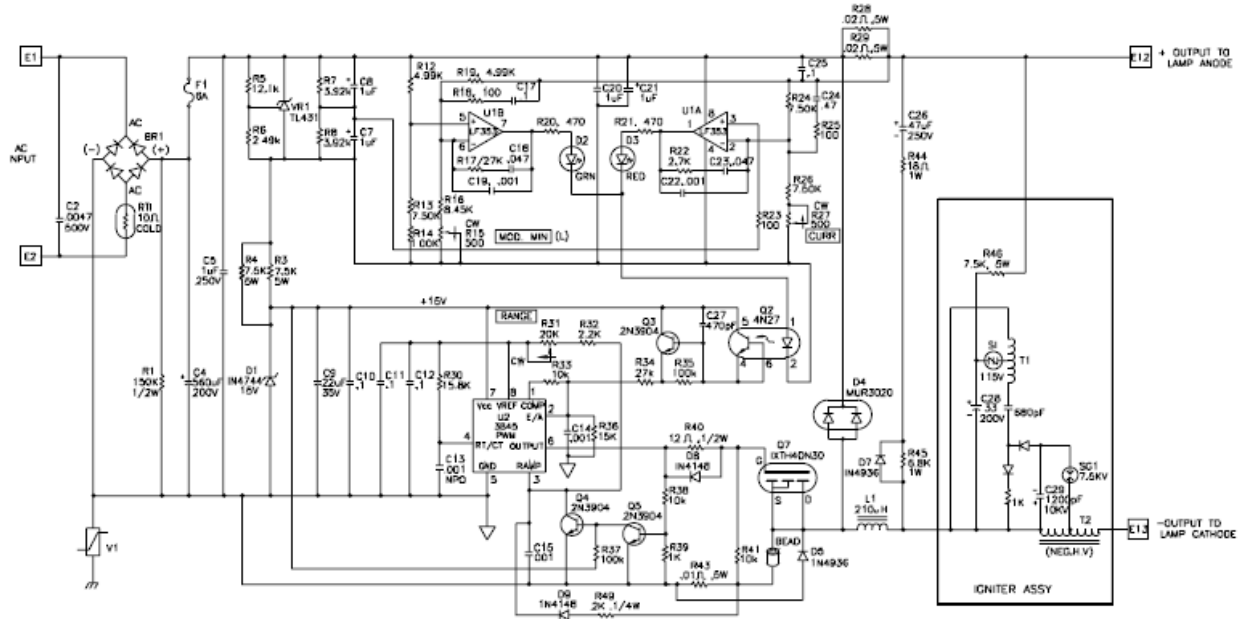

Figure 36: Typical complete Cermax lamp power supply (PS175SW-1). See text.

When Q7 stops conducting, the magnetic field in L1 changes polarity, forward-biasing D4 and supplying current through the lamp during the off- period. All the other circuit elements are devoted either to igniting the lamp or to regulating Q7 on and off time to keep the lamp running at the correct current. Resistors R28 and R29 sense a voltage proportional to current; OpAmp U1 amplifies and filters the voltage, then drives the opto isolator Q2 to transfer the signal to the other rail of the power supply. On the lower rail, IC U2 controls the pulses to Q7 to keep the lamp running at the correct current.

The lamp trigger circuitry is in the box to the right of the schematic. Before the lamp lights, the rectified AC line voltage (160 VDC) appears at the lamp terminals. This voltage, appearing across R46, C28, and SI, causes the sidac (SI) to go into oscillation, driving T1 with high frequency pulses. Transformer T1 steps the 160 volts up to 7500 volts, which is used to charge C29. When C29 charges to the breakover point of the spark gap SG1, the charge on C29 is discharged through T2 and the voltage is further stepped up to the 20 to 40 kV needed for lamp ignition. When the lamp triggers, C26, R44, and R45 supply the boost, since C26 has been charged to 160 volts. When the boost drives the lamp impedance down to the normal running voltage of 12 to 15 volts, the ignition circuit automatically shuts off,

because the sidac SI will not oscillate below 115 volts.

#### 4.5 Electromagnetic Interference (EMI)

EMI generated by the lamp and power supply is important for two related reasons:

1. The noise often interferes with nearby equipment, particularly video circuits.
2. Various safety and governmental agencies limit the conducted and radiated emissions from equipment that contains the lamp and power supply.

The noise that results from the power supply switching frequency is usually low enough in frequency (20 to 500 kHz) that the conducted emission can be handled with normal line filters, and the radiated emission wavelength is long enough that the equipment chassis does not need special EMI shielding.

However, the lamp can generate very high-frequency EMI if it is operated at low currents. Even with a very well-regulated supply and with RF bypass capacitors, the lamp plasma can generate noise in the 1 to 500 MHz range if it is operated below its noise threshold current. The noise threshold current is a current level below which the plasma generates noise and above which the lamp is quiet. Each lamp has a noise threshold current that is about 80% of the maximum lamp current. This noise threshold is

easily detectable with an oscilloscope voltage probe fairly close to the lamp. The noise threshold varies by an amp or two from lamp to lamp of the same model number. The threshold increases slightly as the lamp ages. This plasma noise does not harm the lamp, but presents problems for the system designer and can be avoided by operating the lamp above the threshold.

## 5.0 Lamp Operation and Hazards

### 5.1 Lamp Cooling

In systems with arc lamps, the most common design fault is failure to adequately cool the lamp. With Cermax® Xenon lamps, this cooling task is made easier because of unique Cermax features:

1. The lamp cannot be overcooled with normal fan cooling systems, as some metal halide lamps can.
2. Only one maximum temperature requirement must be met.
3. The lamp is designed to fit into heatsinks with standard machining tolerances and the cooling air flow is easily achieved with standard fans.
4. Because of the sealed reflector, air flow is not required in tightly constrained spaces, as it is in some reflectorized metal halide lamps.

Cooling by forced air is the most common and convenient cooling method for Cermax lamps. Standard heatsinks and lamp holders are commercially available. However, other cooling methods are possible.

For operation at low wattages, typically less than 100 watts, free convection cooling may be sufficient if the measured lamp temperatures are below the specified maximum.

Cermax lamps can be conduction cooled. This method is occasionally used in sealed containers where the heat is extracted directly to the walls of the container.

Water cooling is also used. No standard water cooling systems are yet available, but tests indicate that the lifetimes of standard lamps are increased by water cooling.

Also, water cooling is the easiest way to extend a Cermax lamp to higher power. Special water-cooled Cermax systems have achieved 4000 watts in continuous operation and repeated pulsing to 8000 watts for 10 seconds.

Heatsink compound is required between the lamp and the heatsink in commercially available forced convection lamp holders. Consult the heatsink

compound instructions included with each lamp to ensure adequate application of the compound. Electrically insulating compound is recommended, because of the possibility of arc-over during ignition when an electrically conductive compound is used.

Cermax lamps should never be operated with the window facing upward or within 45° of facing upward. In operation, there is a very pronounced thermal convection cell inside the lamp. In horizontal operation, this cell heats the upper surface of the ceramic. However, in vertical operation, this cell heats the lamp window, causing both excessive and non-uniform heating. In addition, in vertical operation, the convection cell is operating in opposition to the ion flow in the lamp arc, causing arc instability and lamp flicker.

Forced-air cooling is required only when the lamp is operating. Forced air is not required after the lamp has been extinguished, because the lamp's thermal time constants do not allow internal lamp temperatures to rise after turn-off.

Figure 37 shows typical steady-state 300-watt lamp body temperatures achieved with standard heatsinks and lamp holders. The critical temperature limit is 150°C. For achieving the rated lifetime, and for allowing a possible 20°C rise in ambient air temperature (to 45°C), no part of the lamp should exceed 150°C during steady-state 20°C ambient operation. There is also margin in the 150°C spec to allow for a slight rise in lamp temperature throughout the lamp's lifetime and also for lamp-to-lamp variations in temperature. From Figure 37, it is clear that the part of the lamp that usually reaches this temperature limit first is the top of the ceramic body. This top center ceramic temperature should be checked whenever a new system is initially tested, to ensure that there is enough air flow through the lamp holder and the system. This temperature can be checked with a thermocouple. (Be careful to avoid dangerous arc-overs during ignition or operation.) It can also be checked with temperature-sensitive paints or with temperature-indicating stickers. After the ceramic temperature is verified to be under 150°C, other parts of the lamp body should be checked at least once to verify that no other part of the lamp exceeds 150°C. The lamp window requires special equipment (an infrared pyrometer) to check its temperature. It is also good practice, during qualification testing of a new system, to check actual air flow against the

published fan curves to verify that the fan is operating on a stable part of its air-flow curve. Normal fan cooling systems cannot overcool Cermax® Xenon lamps. However, if very highly directed air flow, such as compressed-gas jets, is used to cool the lamp, testing should be done to ensure that the ceramic body and the lamp window are not overstressed thermally.

### 5.2 Electrical and Mechanical Connections

Most electrical connections and mounting schemes for Cermax lamps involve clamping a heatsink to the cylindrical body of the lamp. In general, electrical connections to the lamp and to all parts of the electrical system should be low-resistance contacts. Five milliohms or less is a good contact resistance goal for these connections. Such connections should have locking mechanisms (lock washers, etc.). It is possible to cause lamp failure by applying excessive clamping force to a Cermax lamp. The clamping force should be applied only until the clamp or heatsink firmly grabs the lamp's metal parts and no longer allows manual rotation of the clamp or heatsink.

The lamp tip-off should always be protected from mechanical damage when the lamp is mounted in any cooling system.

### 5.3 Lamp Safety

Cermax lamps are the safest xenon arc lamps available. They are also safer than most mercury and metal halide lamps.

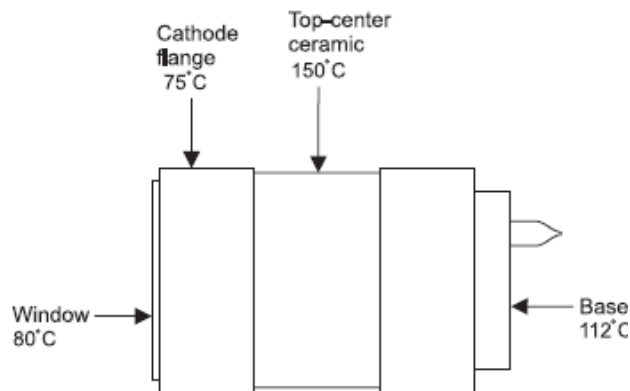

Figure 37: Typical measured temperatures on 300-watt Cermax lamps.

However, there are handling and operating risks involved with Cermax lamps, just as there are with any device in which hundreds of watts of power are concentrated in a small volume. Every user should

read the operating hazards sheet shipped with the lamp, or consult the operating manual if the lamp is incorporated in a light source. There may be warnings specific to the particular lamp model or piece of equipment.

This discussion is not intended as a replacement for reading the operating hazards sheet.

#### 5.3.1 Explosion hazard

Even though Cermax lamps are under high pressure, their explosion during operation is rare and their explosion while not operating is very rare. Most original equipment manufacturers (OEMs) that install hundreds or thousands of Cermax lamps in their equipment never experience an explosion. Thousands of Cermax lamps are used every day in hospital operating rooms for endoscopic procedures with no explosive failures.

Personnel who handle quartz xenon short-arc lamps, such as those used in cinema projection, are required to wear heavy-duty gloves, flak jackets, and face shields. These precautions are not required with Cermax lamps. Even metal halide short-arc lamps that are below atmospheric pressure when cold are very high-pressure during operation. Though the internal pressures of Cermax lamps are comparable to those of operating metal halide lamps, the ceramic construction of a Cermax lamp makes the lamp body much stronger, and in the event of a body fracture, the lamp does not shatter into many small fragments.

Each Cermax lamp is pressure-tested to two to three times the cold fill pressure during manufacture. Nevertheless, the lamps must be handled with the same care and caution given any vessel containing these levels of pressure. Cermax lamps with 1-inch-diameter windows contain about 43 joules of stored potential energy owing to pressure, and 2-inch Cermax lamps contain about 219 joules. For purposes of comparison, a 1-inch Cermax lamp contains about the same stored energy as an aerosol spray can. Face shields or safety glasses are recommended for those who handle the bare lamp, particularly in a manufacturing environment, where lamps are handled continuously.

The most severe abnormal abuse Cermax lamps experience occurs in the case of cooling failure. A thermal cutoff switch is recommended to prevent lamp overheating. Even in the case of an additional

failure of the thermal cutoff, the lamp is unlikely to fail in an explosive manner.

### 5.3.2 High-voltage hazard

The ignition and boost voltages present a high-voltage hazard. The ignition voltage may reach a peak of 45 kV, but the ignition pulse usually contains only a small amount of energy, so its ability to induce harmful currents in the human body is limited. Nevertheless, the boost voltage is high enough, and the current capability large enough, to create a hazard comparable to that of live mains voltage exposure.

### 5.3.3 Ozone

Ozone is a hazard only with UV-emitting Cermax® lamps. The window coating on Cermax lamps with an F suffix prevents the escape of ozone-producing UV from the lamp. Ozone is an irritant in small doses and toxic in large amounts. The recommended threshold limit value for ozone is 0.1 ppm. However, the smell of ozone can be detected at 0.01 to 0.02 ppm. Fatigue and tolerance can set in for workers, so their sense of smell should not be relied on as the primary protection method. Measurements on UV-emitting Cermax lamps indicate that operating them in a 2000 ft<sup>3</sup> space with normal air conditioning prevents buildup above 0.1 ppm except fairly close to the lamp (within 3 feet). To operate UV Cermax lamps in equipment, it is necessary to have some type of air filtration or exhaust system.

### 5.3.4 High light levels

There are no actual regulations that govern exposure to high-intensity light from lamps and lamp systems. However, a recommended set of limits is published by the Illuminating Engineering Society.<sup>37,38</sup> Unfortunately, the recommendations require detailed calculations and reference to weighting tables. We will not attempt to cover those calculations here. Those who use Cermax lamps in products should calculate the recommended limits and make their handling procedures in accordance with them. In this guide, we will only attempt to give general guidelines for exposure.

There is also an ANSI standard for laser safety.<sup>39</sup> Some lamp users calculate the equivalent exposure limits for incoherent sources from the laser requirements and use those maximum exposure limits. The harmful effects of UV and the permissible exposure levels depend heavily on the wavelength. When using a UV-emitting Cermax lamp, either (1)

calculate the exposure limits for the wavelengths used or (2) treat the entire beam on a worst-case basis and enclose and interlock the entire beam path. Even though filtered Cermax lamps do not emit UV, there is a possible blue light hazard that is much less severe than UV hazards. It involves possible blue light photochemical retinal injury. The light levels that cause this hazard are usually only achievable with high-intensity beams shining directly into the eye, as in ophthalmic instruments.

The hazards of visible and infrared radiation are even less than the blue light hazard. Obviously, a radiation level high enough to cause tissue heating is beyond the acceptable exposure level. The best general guideline for this wavelength range is that if the light levels achieved are visually annoying to at least some workers, the light should be shielded and the shield interlocked. Under no circumstances should workers be allowed closer than 2 feet to an unshielded focal spot from a Cermax lamp. Likewise, when the lamp is coupled to a lightguide, the end of the lightguide should not be directly viewed from closer than 2 feet unless the light is attenuated. Under no circumstances should the collimated output from parabolic Cermax lamps be viewed directly unless it is heavily attenuated.

### 5.3.5 Thermal hazards

There are two possible thermal hazards. First, the lamp itself can reach 100–200°C, so it should never be touched until it has cooled. Second, the light from the lamp can almost instantly heat objects in its path. In certain cases, the focal spot can melt steel. Depending on the reflectivity of objects in the beam, the lamp can deposit a large fraction of its total radiated power on objects in the beam. Even after the light has been transmitted through a lightguide, it has enough power to cause severe burns.

### 5.3.6 Lamp disposal

No part of a Cermax lamp is reclaimable. At the end of its life, the gas pressure inside the lamp can be relieved by squeezing the tip-off tubulation until the gas escapes. However, this is not a necessity. If the internal gas pressure is not relieved, care should be taken that the lamp is not incinerated but goes to a landfill. There is a very small percentage of thorium oxide in the Cermax lamp cathode. Thorium is radioactive. However, the amount of thorium is so minute that it is not a hazard and the lamp can be legally disposed of without concern about radioactivity. The radiation levels at 10 cm from the

lamp are 0.001 of permissible radiation levels and 0.006 of the normal background radiation in the U.S. A Cermax lamp material safety data sheet is available on request.<sup>40</sup>

### 6.0 Lamp Lifetime

The first consideration in discussing lamp lifetime is how to define end-of-life. There are a number of definitions.

Warranty lifetime is the minimum lifetime the user is likely to see. In the case of Cermax lamps, warranty lifetime is generally 500 hours, at nominal power, to 50% of initially specified light output.

Typical lifetime is a specified number of hours at which at least 50% of the lamps will achieve some minimum light level at full rated power. Cermax lamps achieve typical lifetimes of 1000 hours or more. The minimum light level can be specified in a number of ways. The most common definition is 75% of initially specified total emitted lumens. Most quartz xenon lamps are defined in this manner because “total emitted lumens” is the only easily defined and measured parameter. All Cermax lamps achieve at least 75% of initially specified total lumens at 1000 hours. However, this definition of light level is not satisfactory in the case of reflectorized lamps, because the light that is useful to the system decreases faster than the total lumens. Therefore, most users would like a specified number of lumens inside a specified aperture size at end of life. For this reason, there is no single end-of-life criterion that satisfies all users. Almost all Cermax lamps will achieve more than 50% of initially specified lumens delivered inside a 6-mm-diameter aperture at 1000 hours for at least 50% of lamps. In fact, even at 2000 hours, most Cermax lamps will achieve this light level.

Figure 16 shows how the cathode hot spot decreases in brightness with lamp age. Figure 22 shows how the hotspot diffuses with age, and Figure 23 shows a more typical representation of lamp aging.

Depending on the aperture size, the lamps in Figure 23 could be defined as 1000-hour or more-than-2000-hour lamps. Also, because of the asymptotic nature of the lifetime curves, a lamp may stay just above or just below 50% for a very long time. The data in Figure 23 are normalized for constant lamp wattage. If the lamp is run at constant current, the lifetime degradation curve will decline less, because the lamp voltage will tend to increase as the lamp

ages. Thus, the power increases slightly and the lumen level stays more constant.

When lamps are operated at reduced power, the lifetime can increase dramatically. Figure 38 shows this increase for standard EX125, EX175, and EX300-10F lamps.<sup>41</sup>

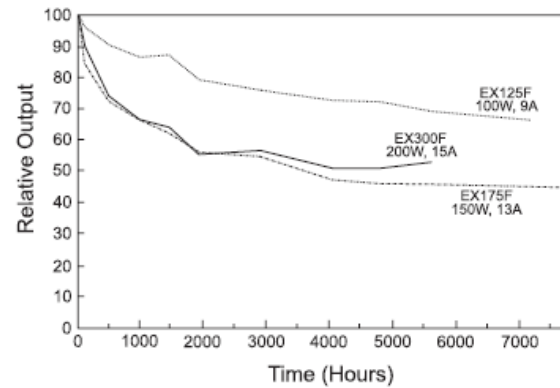

Figure 38: Lifetime curves for standard Cermax lamps run at reduced current. Each curve is the average of three lamps, each run at constant current.

### 6.1 Other Factors Affecting Cermax Lamp Lifetime

Most of the degradation seen on lamp lifetime curves is caused by gradual evaporation of electrode material onto the reflector and window of the lamp. As we have mentioned, the arc gap tends to lengthen as the lamp ages, giving slightly higher operation voltage.

The two most common failure modes at end of life are

1. Failure to meet specified light levels.
2. Failure to ignite.

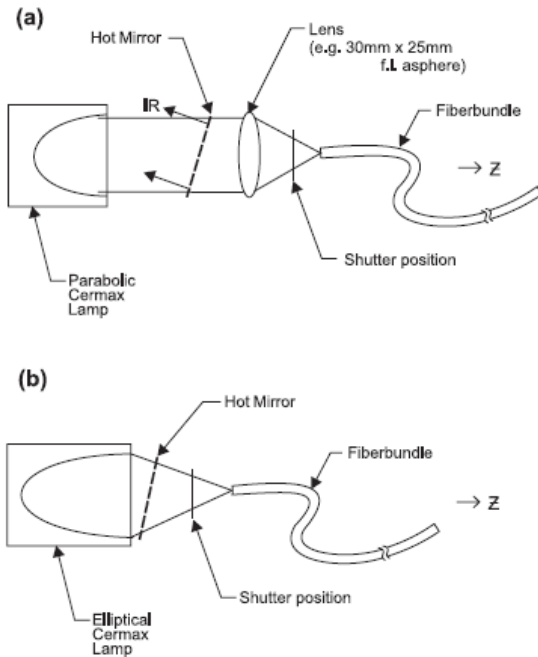

Figure 40: Typical Cermax fiberoptic illumination systems.

Failure to ignite may result from contaminants that evolve as the lamp ages. Additional factors contributing to failure to ignite may be slightly higher operating voltage, deactivation of the cathode tip, and contamination of the ceramic around the anode, leading to abnormal lamp ignition or arc-over to the reflector. If a lamp has been allowed to operate in an overheated state for a significant amount of time, the overheating can cause the arc gap to increase significantly and cause even more overheating from the high-voltage arc gap.

If the lamp is operated past the two normal end-of-life failure modes, at some point it may start to flicker, signaling that the arc cannot find a stable operating point on the cathode. Structural failure of the lamp body is not a normal or expected failure mode, even if the lamp is operated well past end of life.

The amount of low-frequency AC ripple can affect lamp lifetime if it is greater than 10%. This was mentioned in section 4.2.3.

Another factor that can affect lamp lifetime is the number of lamp starts. This is influenced by the design of the starting circuit. Fortunately, Cermax® Xenon lamps are unlikely to be affected by any reasonable number of lamp starts. Even if the lamp

	Numerical Aperture	Acceptance Cone	Transmission Range	Transmission %
Glass	.55-.66	67-82°	360-1,8 μm	35-50%
Liquid Lightguides	.47	56°	250-650 (UV) 300-750 (Vis)	60-80%
Quartz	.3	35°	260-2 μm	30-50%
Eska (plastic)	.47	56°	at least 400-800 nm	similar to glass

Figure 41: Typical lightguide numerical apertures and transmissions.

is started and stopped every hour, the lamp will still achieve rated life.

An important consideration in achieving maximum lamp lifetime is keeping the lamp body as cool as possible. In some cases, lifetime can be extended by decreasing lamp temperature. Conversely, increasing the temperature will shorten lamp life. Optical components placed in front of the lamp can increase lamp temperature by reflecting light back to the electrodes or the reflector. Components such as hot mirrors, filters, heat shields, and so on will decrease lifetime and can cause lamp structural damage if they are positioned to reflect light straight back into the lamp. Sometimes a tilt of 5j to 10j is enough to spoil the reflection and achieve maximum lamp lifetime.

### 7.1 Fiberoptic Illumination

Today, the largest application for Cermax lamps is fiberoptic illumination. Fiberoptic illumination of surgical medical endoscopes is the major subset of this application. In the past, for endoscopic applications less critical than surgery, such as primary care diagnosis, tungsten halogen and metal halide lightsources were considered satisfactory because these lamps provide lower illumination levels at lower cost than Cermax Xenon lamps. However, this perception is changing with the advent of low-cost integrated Cermax lightsources that provide high light levels at low cost.

The unique attributes of Cermax-based endoscope lightsources are:

- High brightness
- White light
- Stable color temperature
- Long life
- Safety
- Ease of lamp replacement
- Pre-aligned reflector

Halogen and metal halide light source limitations have been

- Short lamp life
- Unstable or low color temperature
- Low brightness, particularly when coupled into small fiber bundles

The next largest fiberoptic application for Cermax lamps is industrial fiberoptic (borescope) illumination. These applications have historically used fewer Cermax lightsources than tungsten halogen lightsources because of cost issues. This perception is also changing with the advent of lower-cost Cermax systems and with the increasing use of industrial systems for very critical inspections where high brightness and color consistency are important. The same comments on Cermax lightsource advantages apply for both medical and industrial applications.

Most medical and industrial fiberoptic illumination systems are very similar in optical design. The FDA and other agencies require special testing and safeguards for medical lightsources. Only medically-approved lightsources can be used for medical procedures.

Figure 39 shows a typical Cermax fiberoptic lightsource. Most fiberoptic lightsources run between 150 and 300 watts lamp power. The primary limitation on power in most systems is the damage threshold of the lightguide. Even though many systems have 300-watt lamps, very few commercial systems run at a full 300 watts because of possible lightguide damage.

Figure 40 shows typical fiberoptic illumination systems for Cermax lamps. The primary performance difference between parabolic and elliptical lamp systems is the slightly higher number of lumens per watt achievable with elliptical lamps. Both systems require a hot mirror or some other means of rejecting the infrared light in the Cermax beam. In the case of parabolic systems, a short-focus lens is usually the next element. This lens is chosen to match the numerical aperture of the fiber bundle. For the highest system efficiency, the fastest-focusing lens is chosen that still matches the numerical aperture of the lightguide. Figure 41 shows typical lightguide numerical apertures and transmissions. By far the most common lightguide material is glass. The glass numerical aperture

matches either an f/1 elliptical lamp or an f/1 lens and a parabolic lamp. Quartz fiber bundles are used where lightguides need to be heat- or radiation-resistant or need to match a higher f-number system at the other end of the lightguide. Quartz lightguides typically achieve 50% or less of the output of comparable glass lightguides. When the highest possible throughput is desired, liquid lightguides are used. They are used in industrial systems, but are rarely used in medical systems because of their rigidity and the difficulty of sterilizing them. Various plastic fibers are used in disposable illumination systems.

The next element in typical illumination systems is usually a shutter or brightness control mechanism. Because discharge lamps cannot be electrically attenuated down to low levels, most systems keep the lamp at a set current and introduce a mechanical shutter to attenuate the light to low levels or block it entirely.

The final element in the fiber illumination system is the fiber itself. With high-intensity lamps, it is important to heatsink the fiber to avoid thermal damage. Usually this is done with a close-fitting metal adapter that can transfer heat quickly from the fibers. In some cases, the adapter and even the fiberoptic tip are made of brass or copper to aid in heat transfer. The fiber should be held in a mechanism that allows for x-y translation of the fiber relative to the lamp, because the dimensional tolerance accumulation throughout the optical system does not ensure that the fiber will be at the center of the optical spot. The most common fiber bundle size is 5 to 6 mm diameter. Such a fiber bundle usually requires alignment to  $-0.010$  inch to achieve peak output.

The following additional information may aid in the design of Cermax fiberoptic systems:

1. In most cases, single-element aspheric focusing lenses give the best light output with the least complexity. Aberrations are of secondary concern because the focusing is on-axis and the fiber bundles are usually relatively large (6 mm). Antireflection coating the lens may add 5% to the output.
2. Even with heatsinking the fiber bundle, there is a risk of burning it, because the lamp's focal spot may have a high-intensity peak in the center. Moving the fiber bundle in the z-direction, slightly away from the best focus, blurs the hot



spot yet still achieves more than 95% of the maximum output.

3. Fiber bundles preserve the angles of the incident light. Whatever incident light angles are not present in the input beam will be made evident by dark annular rings in the output beam at those angles. Section 3.3.2 discussed the hole in the beam phenomenon and how to minimize it. Additional methods of smoothing the output involve (1) tilting the fiber bundle relative to the lamp axis to further smear the light angles and (2) pinching the fiber bundle to cause mixing of the reflected angles inside the individual fibers.
4. Most fiber bundles are not fully incoherent or not fully randomized. Because the focal spot at the input to the fiber bundle usually has a peak in the center, some of the fibers carry more light than others. Unless a fiber bundle is specially manufactured to have randomized fibers, the output end of the bundle will have darker and lighter sections.

## 7.2 Video Projection

The high arc brightness characteristic of Cermax lamps has led to their use in a number of video projectors. Even though xenon arc lamps are inherently less efficient than metal halide lamps, when small light valves are being illuminated, Cermax lamps produce more lumens per watt on the projection screen.

Examination of the etendue of the lamp is the key to understanding why Cermax lamps produce more screen lumens. There are a number of related quantities etendue, optical invariant, throughput, and radiance that all describe the way an optical system conserves the directions of the light rays traveling through it. Etendue is the product of the cross-sectional area of a beam ( $A_1$ ) and its projected solid angle ( $A_2/d_2$ ) (See Figure 42). As lenses and other optical elements in the system transform the size of the beam, the etendue either stays constant or, if randomizing elements are inserted into the beam, becomes larger. The etendue can never decrease. Therefore, as a beam decreases in size ( $A_1$  decreases), the divergence of the light ( $A_2/d_2$ ) will increase so that the etendue stays constant. Small light valves require optical systems with small etendues because the valves themselves are small in size. Also, to preserve contrast ratio and to utilize practical lens systems, the light divergence must also stay small as the light strikes the light valve.

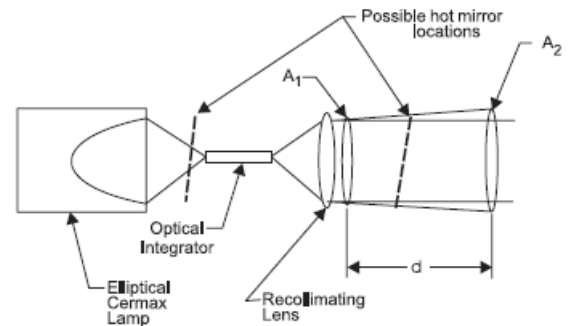

Figure 42: Typical Cermax video projector lightsource

The optical system etendue imposes a corresponding requirement on the lamp. The etendue of a lamp is

$$E = 8\pi L^2 \text{ (sr } \times \text{ mm}^2\text{)}$$

where  $L$  is the lamp arc length in millimeters.<sup>42</sup> Cermax lamps have etendues of between 5 and 15. Metal halide lamps have etendues of between 70 and 400. Even quartz xenon arc lamps have etendues of between 15 and 100. In a large number of cases when the light valve is smaller than about 1 inch (diagonal), the required system etendue is in the 10-to-30 range (depending on the projector lens f-number and the details of illuminating the light valve). Therefore, even though a Cermax lamp has lower efficacy than a metal halide lamp, it matches small-light valve optical systems better and can throw more light on the screen.

Some other characteristics that make Cermax lamps well suited for video projectors are:

- Compact size
- Ease of cooling
- Safe operation
- Stable and reproducible color
- Long life
- Ease of lamp replacement

Every video projector has a unique optical system. We can only describe some of the most common methods of interfacing Cermax lamps with these systems. Figure 42 shows a common interface between a Cermax lamp and a video projector's optical system. Elliptical Cermax lamps are typically used because of their higher reflector efficiency. Fiberoptic lightsources using Cermax lamps rarely run at full power, whereas in video projectors great efforts are made to use all available light output. Video projectors also tend to use higher-power Cermax lamps, typically 500 watts and higher. When

they were developed, the higher-powered Cermax® elliptical lamps were optimized for video projection. This optimization involved compromises among fill pressure, arc gap, and lifetime. Some of the interactions between these factors are as follows:

- Shimmer becomes slightly worse as fill pressure is increased.
- Lamp efficacy decreases as the arc gap decreases, and decreases rapidly as the arc gap decreases below about 75 mm.
- Etendue decreases and coupling efficiency increases as the arc gap decreases and the pressure increases.
- The arc gap and the fill pressure must be balanced so that the lamp voltage stays high and the lamp current stays low enough to provide an acceptable lifetime.
- In general, the lamp lifetime will be longer for lamps with longer arc gaps.

Because of the prevalence of shimmer in the projected light field, optical integrators (see Figure 42) are often used to eliminate shimmer and also to flatten the intensity roll-off at the edges of the screen. Integrators can be optical lightguides, either solid glass prisms with reflective sides or lightguides formed from mirrored plates. Integrators can also take the form of lenticular arrays, usually placed in the expanded part of the beam.

After the beam passes either through the focal spot or through the integrator, it expands to a size that is usually larger than the lamp window, and is collimated. After collimation, the beam passes through the color separation filters or prisms and the other optical elements, and ultimately through the light valve and the projection lens. The infrared must be rejected somewhere in the optical path. If a hot mirror is placed before the first focal point, care must be taken to avoid focusing the infrared back into the lamp. If a hot mirror is placed farther downstream in the optical path, there is a risk of overheating optical elements that are in front of the hot mirror. There is enough concentrated power near the focal point in Cermax lamps to crack or distort glass elements that have a loss of only a few percent. There is enough unfocused light around the focal spot that baffling of the optical path should be done carefully.

To achieve the minimum amount of flicker, it is important that the lamp be operated in the system at the same orientation at which it was initially

burned in. Because convection inside the lamp tends to force the arc upward, the electrodes in arc lamps take a set on a microscopic level as they initially burn in. If the lamp is then run at a different orientation, the arc will need time to take a set on a slightly different part of the electrodes. The time interval needed for this set is typically 10 to 20 hours. During this time, the arc will jump between different areas of the electrodes and the lamp will flicker slightly.

### 7.3 UV Applications

UV lighting applications can be divided into two large arenas: those that need UV exposure over large areas and those that need the UV concentrated in small areas. UV exposure over large areas, such as UV curing of inks, traditionally uses low- or medium-pressure mercury discharge lamps. These are similar to large fluorescent lamps optimized for UV emission. Cermax is not a recommended source for these large-area applications.

For concentrated UV exposure, the most common source is a mercury or mercury-xenon short-arc lamp. Mercury short-arcs are more efficient than quartz xenon short-arc lamps or Cermax lamps for producing UV. However, for certain concentrated UV applications, Cermax lamps have some advantages:

- Cermax lamps have a continuous spectrum in the UV, as opposed to the line spectra of mercury lamps.
- Because of the high collection efficiency of Cermax lamps, even though they are less efficient at producing UV, in many practical systems, Cermax lamps deliver more UV to the target.
- Cermax lamps almost always deliver more UV than mercury lamps through small UV lightguides.
- Cermax lamps can produce UV instantly from a cold start.
- The amount of UV emitted from Cermax lamps is very reproducible because it is not dependent on the cold-spot temperature of the lamp.

As a benchmark, a 300-watt elliptical UV Cermax lamp can deliver more than 2 watts of 300- to 400-nm light through a 6-mm liquid lightguide.

Some of the unique UV applications of Cermax® Xenon are:

- In vivo medical UV curing
- UV curing in manufacturing
- Dental UV curing
- Dye penetrant fluorescence examination

#### 7.4 Other Applications

Other applications for Cermax lamps and lightsources include:

- Machine vision lighting systems
- Microscope illumination
- Spectroscopy
- Soft soldering
- Infrared countermeasure lamps for military applications

## References

1R.Ye. Rovinskiy, Computation of Light and Electric Parameters for Gas Discharge Xenon, Direct Current Lamps, translation, NASA TTF-10, 268 (1966).

2 William T. Anderson, Jr., Xenon Compact Arc Lamps, JOSA 41, 385—389 (1951).

3J.D. Cobine and E.E. Burger, Analysis of Electrode Phenomena in the High-Current Arc, J. of App. Physics 26, 895—900 (1955).

4Wolfgang E. Thouret and Herbert S. Strauss, XenonHigh-Pressure Lamps, Illuminating Engineering, March1952, 150—158.

5 William T. Anderson, Jr., High-Brightness Xenon Compact Arc Lamp, J. of SMPTE 63, 96—97 (1954).

6 Stellar Software, P.O. Box 10183, Berkeley, CA 94709(510-845-8405).

7 Sinclair Optics, Inc., 6780 Palmyra Road, Fairport, NY14450 (716-425-4380).

8 Optis, BP275-F83078, Toulon Cedex 9, France (CompuServe 100302.427)

9 Lighting Handbook, Reference and Applications, edited by Mark S. Rea, Illuminating Engineering Society of North America, 120 Wall Street, 17th floor, New York, NY 10005 (1993).

10 Gunter Wyszecki and W.S. Stiles, Color Science, John Wiley and Sons, Inc., New York, NY (1967).

11 William B. Elmer, The Optical Design of Reflectors, John Wiley and Sons, Inc., New York, NY (1980).

12 An Overview of Flashlamps and CW Arc Lamps, Technical Bulletin 3, ILC Technology, 399 Java Drive, Sunnyvale, CA 94089 (1986).

13 J.L. Emmett, A.L. Schawlow, and E.H. Wienberg, Direct Measurement of Xenon Flashtube Opacity, J.of App. Physics, 35, 2601—2604 (1964).

14 R.E. Rovinskii and G.P. Razumtseva, The Transparency of a Discharge in Xenon at Very High Pressures, publication unknown.

15 Lighting Handbook, Reference and Applications, edited by Mark S. Rea, Illuminating Engineering Society of North America, 120 Wall Street, 17th floor, New York, NY 10005 (1993).

16 ILC Engineering Note No. 210 (EX300-10 lamps), ILC Technology, 399 West Java Drive, Sunnyvale, CA 94089.

17 ILC Engineering Note No. 220 (EX125-10 lamps), ILC Technology, 399 West Java Drive, Sunnyvale, CA 94089.

18 ILC Engineering Note No. 222 (EX175-10 lamps), ILC Technology, 399 West Java Drive, Sunnyvale, CA 94089.

19 ILC Engineering Note No. 225 (EX900-10 lamps), ILC Technology, 399 West Java Drive, Sunnyvale, CA 94089.

20 ILC Engineering Note No. 226 (EX900-13 lamps), ILC Technology, 399 West Java Drive, Sunnyvale, CA 94089.

21 A. Pebler and J.M. Zomp, Stabilizing the Radiant Flux of a Xenon Arc Lamp, App. Optics 20, 4059—4061(1981).

22 R.H. Breeze and B. Ke, Some Comments on Xenon Arc Lamp Stability , Rev.ofSci.Inst. 44, 821—823 (1972).

23 R.L. Cochran and G.M. Hieftje, Spectral and Noise Characteristics of a 300-Watt Emma Arc Lamp, Anal.Chem.49, 2040—2043 (1977).

24 R.E. Rovinskii, Electrical Characteristics of a High-Pressure Xenon Arc, Sov. Phys—Tech. Phys. 8,361—364 (1963).

25 Jack K. Buckley, Xenon Arc Lamps for Modulation, Illuminating Engineering (1962).

26 Jack K. Buckley and Donald R. Gerue, Modulation of Xenon Arc Lamps, preprint.

27 P. Schulz, A. Bauer, and P. Gerthsen, Investigations of Arc Cathodes, Appl. Sci. Research 5B, 210—218(1955).

28 C.F. Gallo and W.L. Lama, Acoustical Resonances in Modulated Compact Arc Lamps, App. Opt. 16, 819—820,(1977).

29 ILC Engineering Note No. 159 (Modulation Characteristics of a 150W Cermax Illuminator System), ILC Technology, 399 West Java Drive, Sunnyvale, CA 94089.

30 ILC Engineering Note No. 152 (Use of Xenon Short Arcs as Pulsed Light Sources), ILC Technology, 399 West Java Drive, Sunnyvale, CA 94089.

31 B.W. Hodgson and J.P. Keene, Some Characteristics of a Pulsed Xenon Lamp for Use as a Light Source in Kinetic Spectrophotometry, Rev. Sci. Inst. 43, 493—496 (1972).

32 Thorkild Hviid and Sigurd O. Nielsen, 35 Volt, 180Ampere Pulse Generator with Droop Control for Pulsing Xenon Arcs, Rev.Sci.Inst. 43, 1198—1199 (1972).

33 ILC Engineering Note No. 226, ILC Technology, 399 West Java Drive, Sunnyvale, CA 94089.

34 A.C. MacKellar, Operation of Xenon Arc Discharge Lamps, Elect. Rev., 30 August 1963.

35 George Chryssis, High Frequency Switching Power Supplies, McGraw-Hill, New York, NY (1984).

36 Eugene R. Hnatek, Design of Solid-State Power Supplies, Van Nostrand Reinhold, New York, NY (1981).

37 Recommended Practice for Photobiological Safety for Lamps Risk Group Classification and Labeling, ANSI/IESNA RP-27.3-96, IES, 120 Wall Street, New York, NY (1966).

38 Recommended Practice for Photobiological Safety for Lamps General Requirements, ANSI/IESNA RP-27.1-96, IES, 120 Wall Street, New York, NY (1966).

39 American National Standard for Safe Use of Lasers, ANSI Z136.1-1993, ANSI, 11 West 42nd St., New York, NY (1993).

40 ILC Engineering Note No. 232 (Cermax Material Safety Data Sheet), ILC Technology, 399 West Java Drive Sunnyvale, CA 94089.

41 R. Roberts, W. Moloney, and F. Schuda, Long-Lived Sealed Beam Xenon Short Arc Lamps for Projection Display, SID, 1996 Int. Symposium, 771—773.

42 P.C. Candry, LCD Projection Technologies and Applications, Asia Display 95, 75—78 (1995).

## Acknowledgments

Thanks to Roy Roberts and Dan O'Hare for the information and data that permitted the writing of this guide. Thanks also go to Heather Brown, Heidi Kelly, and Mary Miller Associates for their invaluable help in the production of this guide.

The first edition of the guide was written by Felix Schuda in January 1998 before ILC Technology was acquired by PerkinElmer and became part of the optoelectronics division and later the Illumination and Detection Solutions (IDS) business unit of PerkinElmer.